

# avocor<sup>TM</sup>

AVF-8650

Large Format Interactive Display



Model AVF-8650 Installation and Operation Manual

## **COPYRIGHT AND TRADEMARKS:**

© Copyright 2019. This document contains proprietary information protected by copyright, trademark and other intellectual property laws. All rights are reserved. No part of this manual may be reproduced by any mechanical, electronic or other means, in any form, without our prior written permission.

The trademarks reproduced in this document and used on the products are either owned or licensed by us, or by their respective holders. You may not reproduce or use the trademarks without our prior written consent.

# Important Safety Instructions

- Before using this display, please read this user manual thoroughly to help protect against property damage and to ensure your personal safety and the safety of others.
- Be sure to observe the following instructions.
- For your safety, be sure to observe the warnings located in this manual.
- For installation or adjustment, please follow the instructions in this manual and refer all servicing to qualified service personnel.

## Safety Precautions

- If smoke or a peculiar smell comes from the display, remove the power plug from the outlet immediately.
- Failure to do so may result in fire or electrical shock. Contact your dealer for inspection.
- **If the display has been turned on but there isn't a picture, remove the power plug from the outlet immediately.**
- Failure to do so may result in fire or electrical shock. Contact your dealer for inspection.
- If water is spilled or objects are dropped inside the display, remove the power plug from the outlet immediately.
- Failure to do so may result in fire or electrical shock. Contact your dealer for inspection.
- If the display is dropped or the cabinet is damaged, remove the power plug from the outlet immediately.
- Failure to do so may result in fire or electrical shock. Contact your dealer for inspection.
- To turn off the power of the display, press "O" on the main power switch at side of display.
- The power standby/on indicator will go off and the display cannot to be turned on/off by using the POWER button on the remote control. (To turn on/off the display by the remote control, press the main power switch again and light the power standby/on indicator.)
  - ◆ When turning off the display by pressing the POWER button on the remote control, the main power of the display is not turned off completely.
  - ◆ To disconnect power completely, remove the power plug from the outlet.
- If the power cord or plug is damaged or becomes hot, turn off the main power switch of the display, make sure the power plug has cooled down and remove the power plug from the outlet.
- If the display is still used in this condition, it may cause fire or electrical shock. Contact your dealer for replacement.

## Installation

- Don't install in a high-temperature environment.
- If the display is used in high-temperature or in direct sunlight, it may cause the case or other parts to become distorted or damaged, resulting in overheating or electrical shock.
- Don't install in a high-humidity environment.
- This may cause overheating or electrical shock.
- Don't install near any heat sources such as radiators, heat registers, stoves, or other apparatus that produce heat.
- This may cause fire or electrical shock.
- Don't overload outlets or cables beyond electrical capacity.
- Don't use extension cords as it may cause fire or electrical shock.
- Don't insert the power plug into an outlet other than 100~240V AC.
- This may cause fire or electrical shock.
  - ◆ Don't use a damaged power plug or worn outlet.
  - ◆ Don't insert an improper power plug it may cause fire or electric shock.
- Don't place the display on an unstable shelf or surface.
- The display may fall, causing injury. Please install on a horizontal, stable, level surface.
- Don't place objects on the display.
  - ◆ If the display is covered or the vents are blocked, the display could overheat and cause a fire.
  - ◆ If metal or liquid gets into the display, it may cause fire or electrical shock.
  - ◆ Do not put heavy objects on the display as they may fall, causing injury.
  - ◆ Please keep a 10 cm minimum distance between the display and the wall for sufficient ventilation.
- Don't move the display when it is connected to the power cord and AV cables.
  - ◆ When moving the display, make sure to remove the power plug and cables from the outlet or source.
  - ◆ When unpacking or carrying the display, at least 2 people are needed. Make sure the display is carried upright.
  - ◆ Transport the display upright. Avoid placing the display face up or down.
  - ◆ Handle the display gently. Do not drop.

## Use

- If you encounter a problem during installation, please contact your dealer for assistance. Don't repair or open the display by yourself.
- Failure to do so may result in fire or electrical shock. Contact your dealer for inspection.
- Protect and correctly use the power cord/plug.
  - ◆ Don't pinch the power cord/plug between hard surfaces.
  - ◆ Don't step on the power cord/plug.
  - ◆ Before inserting the power plug into the wall outlet, connect the power cord to the display.
  - ◆ Don't operate the display with a damaged power cord or it may damage the display.
- Using extension cords (not recommended)
- If an extension cord must be used, ensure the voltage rating exceeds the max power consumption of the display. If the voltage rating is less than the display, it will cause the extension cord to overheat.
- If there is thunder or lightning, don't touch the display or the power plug.
- This may cause an electric shock.
- Don't use any kind of liquid on the display.
  - ◆ If liquid is spilled on the display, remove the power and ask qualified service personnel to check the display.
  - ◆ If the liquid gets on the display's screen, please clean it with a dry and soft cloth immediately.
  - ◆ Don't use any harsh chemical on the display.
  - ◆ If metal or liquid gets into the display, it may cause a fire or an electrical shock.
- Don't install or remove the power plug with wet hands.
- This may cause an electrical shock.
- If the display will not be used for a long period of time, unplug the display.
- This may cause premature wear of electrical components or fire.
- Don't press on the LCD panel.
- This may cause personal injury or panel damage.
- Don't push or shake the display.
- This may cause damage or injury.
  - ◆ If the glass of the display panel is broken, liquid may escape. Please don't touch the liquid.
  - ◆ If liquid get into your eyes or touches your skin, wash with the clean water and seek medical attention immediately.
  - ◆ Precautions with the remote control batteries
  - ◆ Please only use approved AAA type batteries.
  - ◆ Please be sure to insert batteries by matching the + and -.

- ◆ Don't recharge, heat, disassemble, short or throw batteries into a fire.
- ◆ Don't mix a new battery with a used one.
- ◆ Don't mix different types of batteries together (only use the specified type). it may cause burn and injury.

## Cleaning

- If dust has collected on the power plug, remove the plug from the outlet and clean off the dust.
- Dust build-up may cause a fire.
- Take off the power plug before cleaning.
- Failure to do so may result in electrical shock or damage.
- Cleaning the surface of the display
  - ◆ When the surface of the display becomes dirty, please wipe the surface lightly with a soft clean cloth.
  - ◆ If the surface requires additional cleaning, lightly moisten the cloth.
  - ◆ Do not to let any kind of liquid enter the display as it may cause electrical shock or damage.
  - ◆ Do not clean the display with alcohol, solvents or ammonia, as this could damage the display.

# Warnings

## Use

- Do not use the display lying flat on its back.
- Transport the display upright with proper packaging. Avoid placing the display face up or down. Be careful not to bump into the display.
- Do not send a static (non-moving) image to the display, or it may cause image 'burn-in' or image retention.
- "Burn in" and/or image retention is not covered under warranty.
- Make sure to change the image on the display periodically. It is recommended to (1) turn off the display for at least 6 hours after 18 hours of usage in a 24 hour period to help avoid image retention and (2) to turn the "IRFM" function to "ON" in the OSD menu (under "Advanced Settings").

## Exemptions

- This product isn't warranted for any damage caused by natural disaster (such as earthquake, thunder, etc.), fire, acts by third parties, accidents, owner's intentional misuse and fault, or use in other improper conditions.
- This product isn't warranted for incidental damages (such as profit loss or interruption in business, modification or erasure of record data, etc.) caused by use or inability to use of this product.
- This product isn't warranted for any damage caused by inappropriate operation, or from not following the user manual.
- This product isn't warranted for any damage caused by misuse or malfunction through simultaneous use of this product and the connected equipment or software.
- This product isn't warranted for any damage caused by neglect of the instructions described about installation.
- This product isn't warranted for any damage caused by improper installation.
- This product isn't warranted for any damage caused by disassembly, modification or repair by non-authorized service centre or people.

# Compliance Information

## DECLARATION OF CONFORMITY:

Avocor hereby declares that the Product's Model Numbers:

AVF-8650

Conform with the provisions of:

- FCC:  
FCC CFR Title 47 Part 15 Subpart B Class A, CISPR 22  
ANSI C63.4  
ICES-003
- CE:  
EN 55032  
EN 55024  
EN 61000-3-2  
EN 61000-3-3
- cTUVus:  
UL 60950-1  
CAN/CSA-C22.2 No. 60950-1
- CB:  
IEC 60950-1
- CEC:  
California Code of Regulations, Title 20:Division 2, Chapter 4, Article 4, Sections 1601-1609
- BIS:  
IS 13252 (Part 1)
- PSB:  
IEC60950-1

## FCC PART 15:

This equipment has been tested and found to comply with the limits for a Class A digital device, pursuant to part 15 of the FCC Rules. These limits are designed to provide reasonable protection against harmful interference when the equipment is operated in a commercial environment. This equipment generates, uses, and can radiate radio frequency energy and, if not installed and used in accordance with the instruction manual, may cause harmful interference to radio communications. Operation of this equipment in a residential area is likely to cause harmful interference in which case the user will be required to correct the interference at his own expense.

### CAUTION

Any changes or modifications not expressly approved by the grantee of this device could void the user's authority to operate the equipment.



## INDUSTRY CANADA (ICES-003):

CAN ICES-3 (A)/NMB-3(A)

## PRODUCT DISPOSAL:

The Product contains small amounts of tin, lead and/or mercury. Disposal of these materials may be regulated due to environmental considerations.

## DISPOSAL OF OLD ELECTRICAL AND ELECTRONIC EQUIPMENT (Applicable throughout the European Union and other European countries with separate collection programs)



This symbol found on your product or on its packaging, indicates that this product should not be treated as household waste when you wish to dispose of it. Instead, it should be handed over to an applicable collection point for the recycling of electrical and electronic equipment. By ensuring this product is disposed of correctly, you will help prevent potential negative consequences to the environment and human health, which could otherwise be caused by inappropriate disposal of this product.

The recycling of materials will help to conserve natural resources. This symbol is only valid in the European Union. If you wish to discard this product, please contact your local authorities or dealer and ask for the correct method of disposal.

# Notes

# Table of Contents

Important Safety Instructions .....	3
Safety Precautions .....	3
Installation .....	4
Use .....	5
Cleaning .....	6
Warnings .....	7
Use .....	7
Exemptions .....	7
Compliance Information .....	8
Table of Contents .....	11
List of Figures .....	13
1. Introduction .....	15
About This Manual .....	15
Target Audience .....	15
Textual and Graphic Conventions .....	15
Using This Manual .....	16
Description, Features and Benefits .....	17
Key Features and Benefits .....	17
Touch Capability .....	17
Parts List .....	17
2. Controls and Functions .....	18
Display at a Glance .....	18
Input Panel .....	20
Remote Control Unit .....	22
3. Installation .....	24
Remote Control .....	24
Notes on Batteries .....	24
Notes on Remote Control Operation .....	24
Quick Setup .....	25
Installation Considerations .....	25
Ambient Light .....	25
Ambient Heat .....	25
Ventilation .....	26
Mounting the Display .....	26
Connections to the Display .....	27
Connecting a Control System or PC .....	27
Connecting Source Components to the Display .....	28
Turning on the Power .....	30
Changing the OSD Language .....	30
Enabling the Touch Screen .....	30
Software Installation .....	31
4. Operation .....	35
Using the On-Screen Menus .....	35
Input Menu .....	37
Display Settings .....	39

Audio Menu .....	41
Basic Settings .....	42
Advanced Settings .....	43
Information .....	46
5. Maintenance and Troubleshooting .....	47
Maintenance .....	47
Troubleshooting .....	47
6. External Control .....	50
Serial Communications .....	50
RS232 Connection and Port Configuration .....	50
Command and Response Format .....	50
Command and Response Examples .....	51
Serial Command List .....	51
Using Discrete IR Codes .....	57
IR Command Protocol .....	57
IR Control Code List .....	57
7. Specifications .....	58
Supported Timings .....	59
Overall Dimensions .....	61
Appendix I: Moving and Carrying Notice .....	64
Moving the Display .....	64
Carrying the Display .....	64
Appendix II: Installing a Wall Mount .....	65
Appendix III: Installing an OPS Module .....	66
Appendix IV: Wall Mount Safety Notes .....	67
Appendix V: Ethernet Remote Control Settings .....	69
Configurations .....	69
Administrator .....	69
TCP Mode .....	72
UDP Mode .....	73
UART .....	74
SMTP .....	75
Reset Device .....	76

# List of Figures

- Figure 2-1. Display Front/ Side /Rear View ..... 18
- Figure 2-2. Display Input Panel Left/Right View ..... 20
- Figure 2-3. Display Remote Control Unit ..... 22
- Figure 3-1. Ventilation Requirements for Enclosure Mounting..... 26
- Figure 3-2. RS232 Control System Connection..... 27
- Figure 3-3. Ethernet Connection ..... 28
- Figure 3-4. DisplayPort Source Connection ..... 28
- Figure 3-5. HDMI Source Connections ..... 29
- Figure 3-6. VGA Source Connections..... 29
- Figure 3-7. Touch Screen Controller (USB) Connection..... 30
- Figure 4-1. OSD Menu Structure..... 36
- Figure 7-1. AVF-8650 Display Dimensions (inch) ..... 61
- FIGURE 7-2. AVF-8650 DISPLAY DIMENSIONS (MM) ..... 62

# Notes

# 1. Introduction

## About This Manual

This Owner's Manual describes how to install, set up and operate the Avocor Series LED Display.

Throughout this manual, the Avocor Series LED Display is referred to as the "display".

## Target Audience

The manufacturer has prepared this manual to help installers and end users get the most out of the display.

The manufacturer has made every effort to ensure that this manual is accurate as of the date it was printed. However, because of ongoing product improvements and customer feedback, it may require updating from time to time.

## Textual and Graphic Conventions

Text Conventions: The following conventions are used in this manual, in order to clarify the information and instructions provided:

- Remote and built-in keypad button identifiers are set in upper-case bold type; for example, "Press **EXIT** to return to the previous menu."
- Computer input (commands you type) and output (responses that appear on-screen) is shown in monospace (fixed-width) type; for example: "To change the aspect ratio to Letterbox, type 07 00 02 41 53 50 03 08 <OK>."
- All keys with functional names are initial-capped, set in bold type and enclosed in angle brackets. These keys are the following: <OK>, <Spacebar>, <Control>, <Esc> and <Tab>. <OK> indicates that you may press either the EXIT or OK key on your keyboard if it has both keys.
- In addition to these conventions, underlining, bold face and / or italics are occasionally used to highlight important information, as in this example:



**NOTE** A carriage return must be used after each command or string.

Graphic Conventions: These symbols appear in numerous places throughout the manual, to emphasise points that you must keep in mind to avoid problems with your equipment or injury:



TIP

TIPS highlight time saving short cuts and helpful guidelines for using certain features.



NOTE

NOTES emphasize text with unusual importance or special significance. They also provide supplemental information.



CAUTION

CAUTIONS alert users that a given action or omitted action can degrade performance or cause a malfunction.



WARNING

WARNINGS appear when a given action or omitted action can result in damage to the equipment, or possible non-fatal injury to the user.



DANGER!

DANGER appears when a given action can cause severe injury or death.

## Using This Manual

Use the following table to locate the specific information you need in this manual.

If you need...	... Turn to page:
General information about the Avocor Series LED Display	<a href="#">17</a>
Installation instructions	<a href="#">24</a>
First-time configuration instructions	<a href="#">30</a>
Advanced configuration instructions	<a href="#">43</a>
Troubleshooting tips	<a href="#">47</a>
Product specifications	<a href="#">58</a>



## Description, Features and Benefits

The Avocor AVF-8650 Displays are ultra-high definition touch displays that support a full 3840x2160 @60Hz resolution and can display 10bits, 1.07G colours.

They combine ultra-high resolution and unparalleled image quality with configurable I/O in a large-format display for a wide range of digital signage and control-room applications.

### Key Features and Benefits

The display offers these key features and benefits:

- Up to 3840x2160 @60 Hz resolution
- High-speed InGlass™ touch sensing for up to 20 points and 4 passive pens (for Windows system)
- Diverse video connectivities including (5) HDMI 2.0 inputs and DisplayPort 1.2 input with HDCP, and VGA
- Multiple control connectors including RS-232, USB 2.0/3.0, Touch USB, and LAN connections
- OPS (Open Pluggable Specification) slot
- Full-range internal speakers modules
- Compliance with windows 7/8/10, and Mac OS
- Flexible ON/OFF scheduler
- Long lifetime with high reliability

### Touch Capability

- Precise, highly responsive touch technology
- High touch sensitivity – no pressure required
- Any touch: finger, gloved hand or pointer
- Calibrated easily by provided software tools
- Compliant with Windows 7/8/10 and Mac OS
- Supports 4 passive pens in Windows system
- One USB cable for easy Plug-and-Play operation

### Parts List

Your display is shipped with the following items. If any items are missing or damaged, please contact your dealer or Customer Service.

- Avocor UHD LED Display
- Remote Control Unit and Batteries
- AC Power Cord (US, UK, and Europe)
- 2 Touch Styluses
- 5 cable clips
- USB Key – User Manual
- USB Cable - 3 Metres
- HDMI Cable - 3 Metres
- QSG

## 2. Controls and Functions

### Display at a Glance

Figure 2-1 shows the key display components, and the paragraphs that follow describe them.

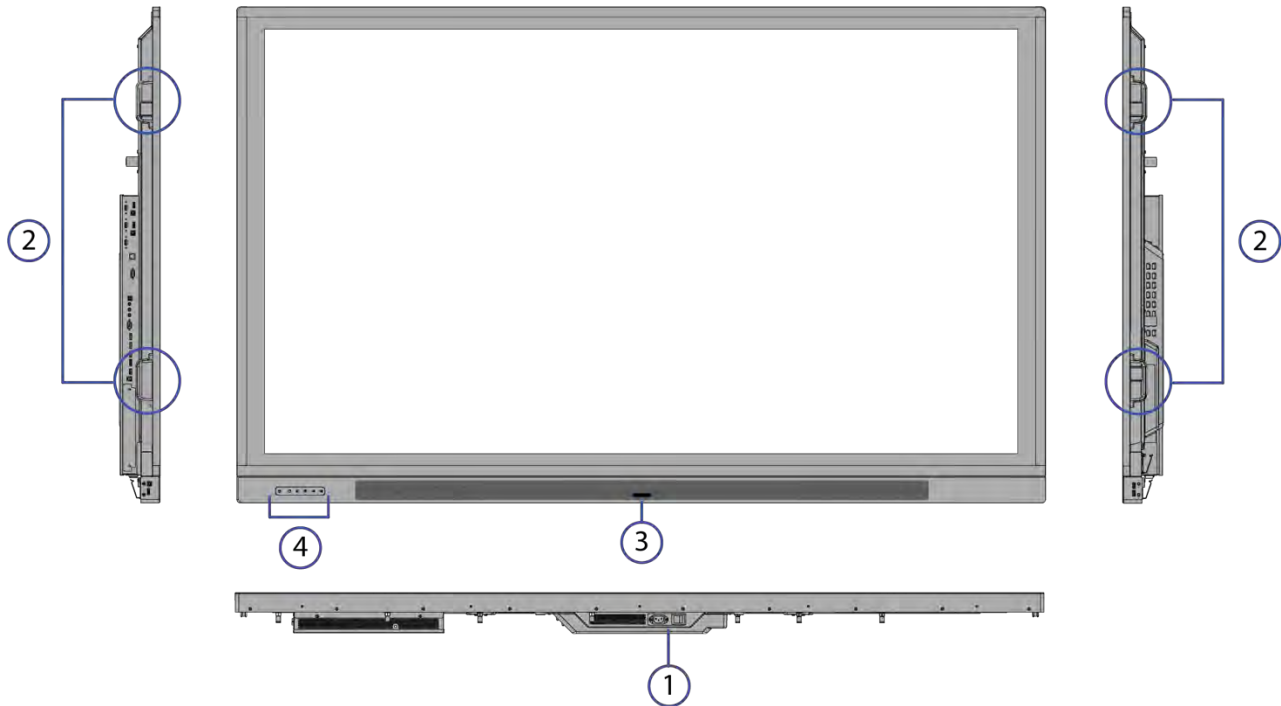

**Figure 2-1. Display Front/ Side /Rear View**

1. MAIN POWER SWITCH  
Connects or disconnects the display panel from the AC power source.
2. HANDLE  
Always use the handles and lower handle bars when carrying the display.  
DO NOT touch/hold the screen face or the lower front panel.
3. Status LED  
Solid green: display on, input detected  
Blinking orange: display on, no input detected  
Solid orange: display in power saving mode  
Off: main power switched off

#### 4. KEYPAD



You can use the keypad instead of the remote control unit to operate the on-screen display (OSD) controls. The keypad operates as follows:

LED light of inductive keys

Blue: light on for 5 seconds when the keys are pressed

Power key breathing light: display go to sleep at digital mode (Digital, RS232, Ethernet)

POWER 

Press the button to turn on/off the monitor screen.

Home 

Press the button to select the home source..

Home source is selectable on the OSD menu. For more information about selecting a home source input, refer to *Display Settings – Home Source*.

SOURCE 

Press the button to select a media source.

Press and hold the button to go through the input sources.

WPS 

Press the button to select WPS input.

VOLUME DOWN  / UP 

Press these two buttons to lower or increase the volume.

Press and hold the button to continuously lower or increase the volume.

# Input Panel

Figure 2-2 shows the display input panel.

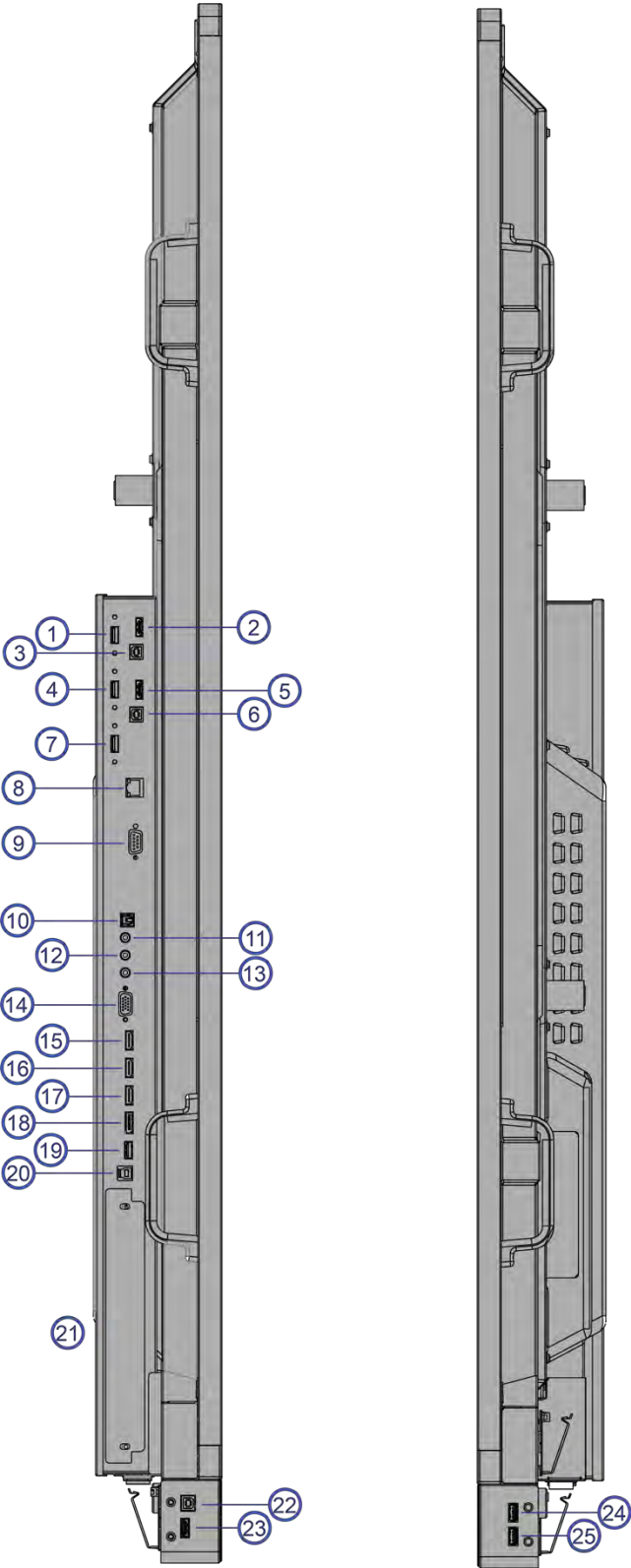

Figure 2-2. Display Input Panel Left/Right View

No.	Connector
1	OPS USB 3.0 A standard USB connector of the OPS slot for connecting external multimedia player devices.
2	WPS WPS(HDMI) input for connecting Wireless Presentation sources to the display.
3, 6, 22	Touch USB Standard, Type-B USB 2.0 ports for connecting touch sources to the display.
4, 7	HUB USB 3.0 Standard USB 3.0 type A connectors for connecting external media, keyboard, keyboard or mouse.
5, 16, 17, 23	HDMI 1, 2, 3, 4 HDCP-compliant HDMI 2.0 digital video input for connecting HDMI sources.
8	LAN An RJ-45 connector for interfacing with a PC or home theater automation/control system via a Cat 5 cable.
9	RS232C A female, 9-pin D-sub connector for interfacing with a PC or home theatre automation/control system.
10	SPDIF Connects external and powered digital speakers or audio receiver/amplifier.
11	Audio Out Connects external, powered speakers or an external audio receiver/amplifier.
12	IR Connects an IR Extender cable from this input.
13	Audio In Connects the audio output from a personal computer here.
14	VGA Connects components that have RGB or component output jacks, such as a personal computer or external DTV decoder (a break-out cable is needed for BNC-type connection).
15	HDMI Out HDCP-compliant HDMI output that will support inputs HDMI 1, HDMI 3, DisplayPort, & WPS.
18	DisplayPort DisplayPort 1.2 and DisplayPort-HDCP 1.1 compliant, SD/HD input for connecting SDTV, EDTV or HDTV component video sources.
19	Service Port A standard USB Type A connector for connecting the USB stick that comes with the package to upgrade firmware.
20	Touch USB HUB 3.0 in Type-B USB 3.0 port for connecting touch and media sources to the display for ports 14, 16, 17 & 18.
21	OPS (Open Pluggable Specification) Slot An optional OPS slot for connecting an internal PC to display 4K content.
24	OPS USB A standard USB 2.0 connector of the OPS slot for connecting external multimedia player devices.
25	HUB USB Standard USB 2.0 type A connectors for connecting external media, keyboard, keyboard or mouse.









# Remote Control Unit

Figure 2-3 shows the display remote control, and Table 2-1 describes its functionality.



**Figure 2-3. Display Remote Control Unit**

Table 2-1. Remote Control Button Descriptions

Button	Description
	Power Turns the display screen on and off
	Home/OPS Selects the home source Home source is selectable on the OSD menu. For more information, refer to <i>Display Settings – Home Source</i> .
	Source Selects a media source
	Navigation arrows Navigates through submenus and settings
	OK Confirms the selection
	Exit Exits the OSD menu
	Volume down Turns down the volume
	Volume up Turns up the volume
	Menu Opens the OSD menu

Hot keys for lock and unlock the remote control and built-in keypad

- Lock: To lock the remote control and built-in keypad, press **OK, OK, ↩, ↩, OK** and **↩** on the remote control. (This will not lock RS232 and Power On control.)
- Unlock: To unlock the remote control and built-in keypad, press **OK, OK, ↩, ↩, OK** and **↩** on the remote control.

# 3. Installation



NOTE Installation must be performed by a qualified custom video installation specialist.

## Remote Control

To install batteries in the remote control:

1. Press down the tab on the cover and pull the cover up.
2. Insert the included batteries. Ensure that the polarities correctly match the  $\oplus$  and  $\ominus$  markings inside the battery component.
3. Insert the lower tab of the cover into the opening, and press down the cover until it clicks in place.

## Notes on Batteries

Make sure that the battery polarities are correct when installing the batteries.

- Do not mix an old battery with a new one or different types of batteries.
- If you will not use the remote control for a long time, remove the batteries to avoid damage from battery leakage.
- Do not expose batteries to excessive heat such as from sunshine, fire or the like.

## Notes on Remote Control Operation

- Make sure that there is nothing obstructing the infrared beam between the remote control and the IR receiver on the display.
- If the effective range of the remote control decreases, or it stops working, replace the batteries with new ones.
- The remote control may fail to operate if the infrared remote sensor is exposed to bright sunlight or fluorescent lighting.
- Ambient conditions may possibly impede the operation of the remote control. If this happens, point the remote control at the display, and repeat the operation.



## Quick Setup

Table 3-1 gives a quick overview of the display installation process. The sections following this one provide detailed instructions.

Table 3-1. Installation Overview

Step	Procedure	For Details Refer to page...
1	Mount the display(s) on a wall (optional)	<a href="#">26</a>
2	Connect other external equipment to the display (optional): Automation/control system (RS232, Ethernet)	<a href="#">27</a>
3	Connect signal sources to the display	<a href="#">28</a>
4	Apply power to the display	<a href="#">30</a>
5	Change the OSD language (optional)	<a href="#">30</a>
6	Perform touch screen-specific installation and configuration tasks (Avocor): Connect touch screen controller host computer to the display	<a href="#">30</a>
7	Display calibration - adjust the following <i>for each input</i> : <ul style="list-style-type: none"><li>• Aspect ratio</li><li>• Brightness</li><li>• Contrast</li><li>• Color temperature and white balance</li><li>• Color level</li><li>• Tint</li><li>• Input position</li></ul>	<a href="#">37</a>

## Installation Considerations

Proper installation of your display will ensure a satisfying viewing experience. Whether a display is installed temporarily or permanently, the following should be taken into account to ensure the best performance of the display.

### Ambient Light

In general, minimise or eliminate light sources directed at the screen. Contrast ratio in your images will be noticeably reduced if light directly strikes the screen, such as when a shaft of light from a window or floodlight falls on the image. Images may then appear washed out and less vibrant. Direct sunlight may affect touch operation.

### Ambient Heat

Keep the ambient temperature constant and below 40°C (104°F). Keep the display away from heating and/or air conditioning vents.

## Ventilation

If you are mounting the display in an enclosure, leave sufficient space on all sides between it and surrounding objects, as shown in Figure 3-1. This allows heat to disperse, maintaining the proper operating temperature.

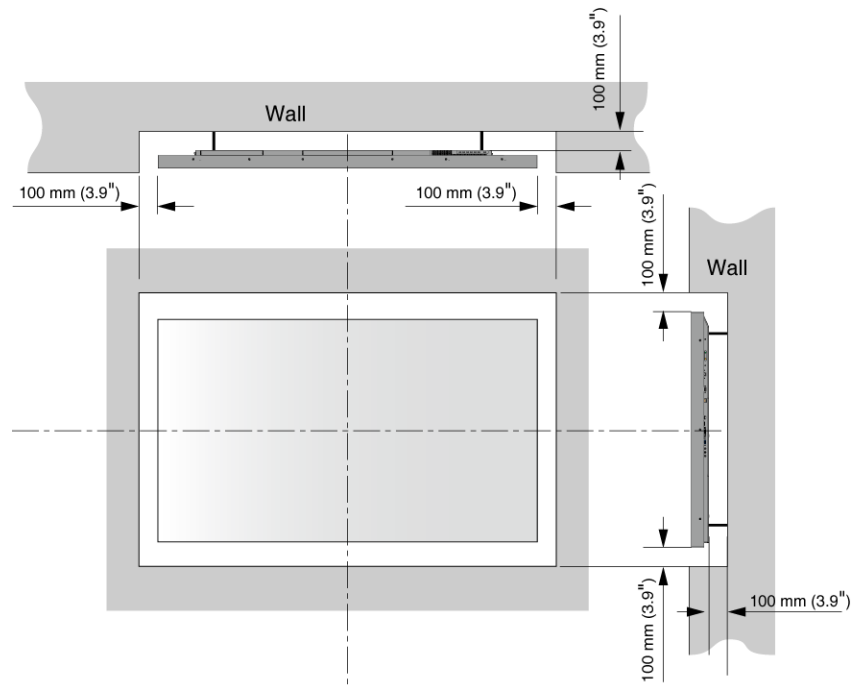

**Figure 3-1. Ventilation Requirements for Enclosure Mounting**

## Mounting the Display

You can mount the display on a wall.

If you do decide to wall-mount the display, ensure that the wall-mount bracket is installed according to the instructions included with it. The wall must be capable of supporting a redundant weight factor three (3) times the weight of the display, or be reinforced.

We recommend that this be done by a custom installation specialist.



### NOTE

To safely mount the display on a wall:

- Use only the approved wall-mount kit designed for the display.
- Make sure the tilt degree of the wall does not exceed 2 degrees.

For more information of wall mount installation, refer to Appendix II: Installing a Wall Mount on page 65.

## Connections to the Display

Proceed as follows to connect the display to your video sources, external controller(s) – if present – and AC power.

When connecting your equipment:

- Turn off all equipment before making any connections.
- Use the correct signal cables for each source.
- For best performance and to minimise cable clutter, use high-quality cables that are only as long as necessary to connect two devices. (Don't use a 7m cable when a 1.8m cable will suffice.)
- Ensure that the cables are securely connected. Tighten the thumbscrews on connectors that have them.

### Connecting a Control System or PC

#### RS232 Connection

Use a straight-through RS-232 cable with a 9-pin male connector to connect a PC or control/ automation system (if present) to the RS-232 port on the display; see Figure 3-2.

For more information about using this connection, refer to External Control on page 50.

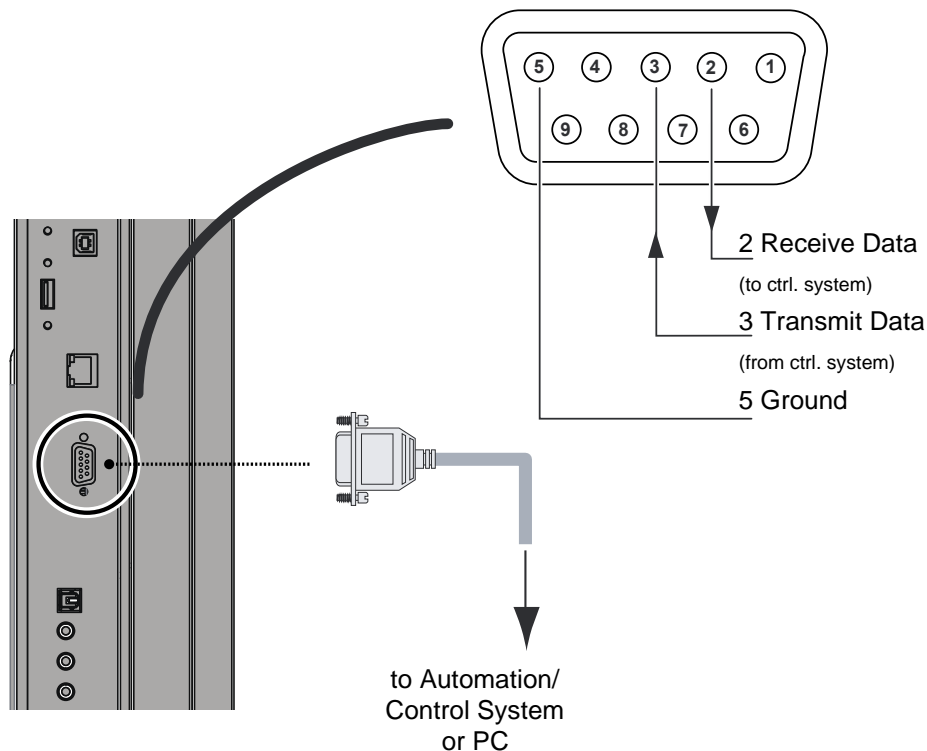

**Figure 3-2. RS232 Control System Connection**



**NOTE**

The RS232 connection may vary with different control system. If there is any problem regarding the connection, please contact our customer service for further assistance.

## Ethernet Connection

Use a standard Ethernet cable with an RJ-45 male connector to connect a PC or control/automation system (if present) to the Ethernet port on the display.

For more information about using this connection, refer to External Control on page 50.

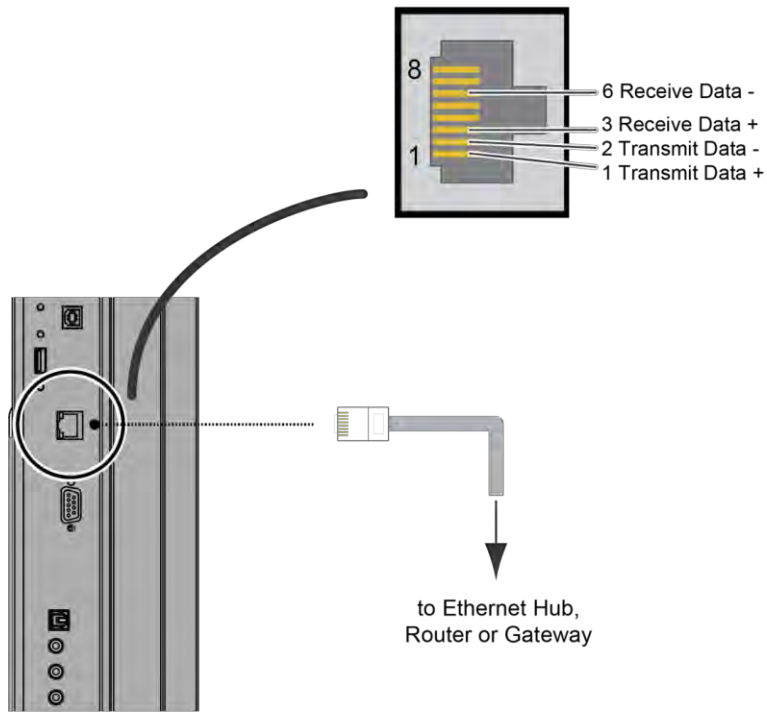
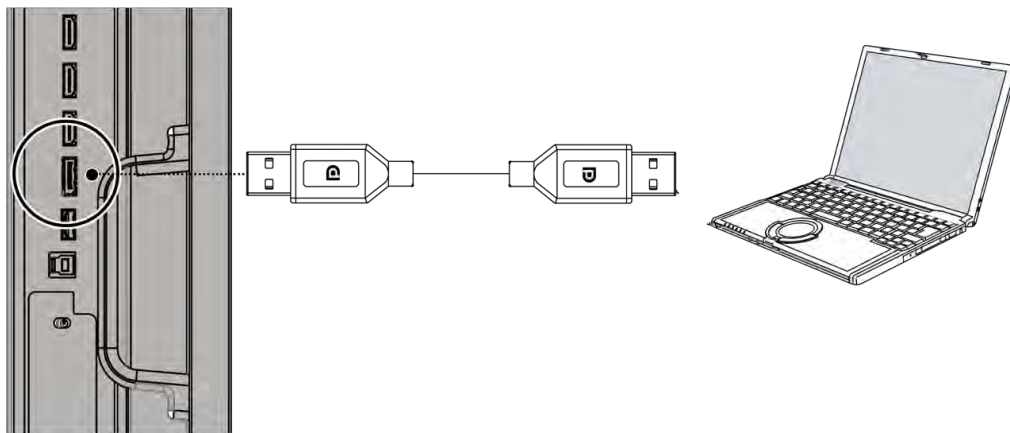

**Figure 3-3. Ethernet Connection**

## Connecting Source Components to the Display

Connect your video sources to the display as shown and described in the sections that follow.

DisplayPort Source Connection: See Figure 3-4.

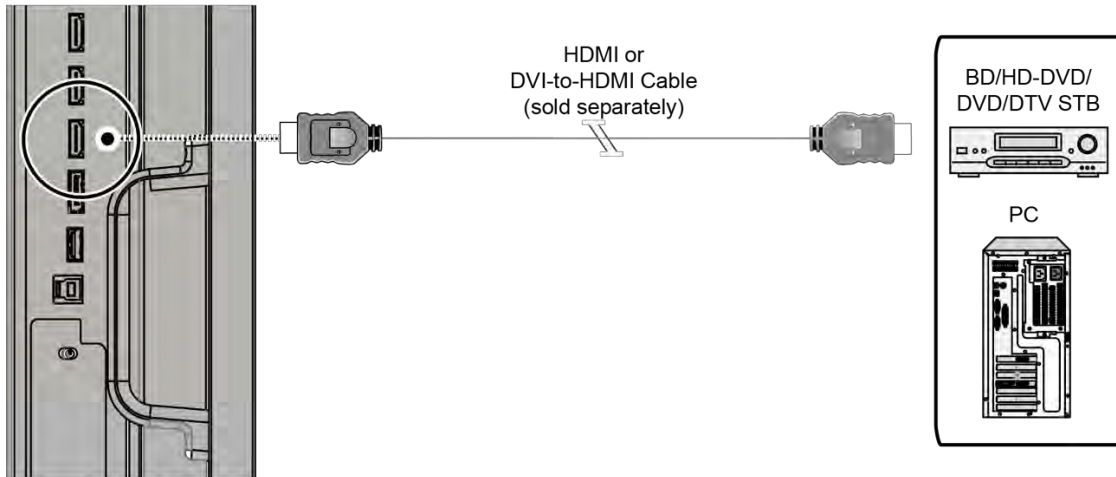

**Figure 3-4. DisplayPort Source Connection**

HDMI Source Connections: See Figure 3-5.



**NOTE** This display supports the VESA Display Data Channel (DDC) standard. This standard provides "Plug and Play" capability; the display and a VESA DDC-compatible computer communicate their setting requirements, allowing for quick and easy setup.  
For Plug and Play to work correctly, you must turn on the display before you turn on the connected computer.



**Figure 3-5. HDMI Source Connections**

VGA Source Connection:

Connect a personal computer or other RGB source to the VGA input as shown in Figure 3-6.



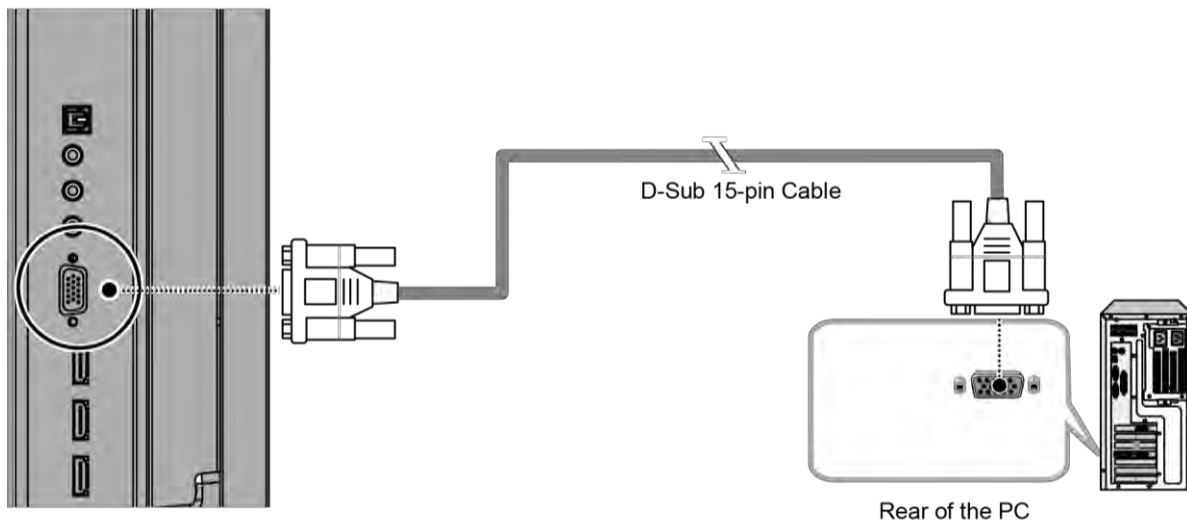

**NOTE** Refer to Supported Timings on page 59 for a list of compatible input signals.



**Figure 3-6. VGA Source Connections**

## Turning on the Power

1. Turn on your source components.
2. Plug the female end of the supplied power cord into the AC receptacle on the side of the display (AC 100V ~ 240V). See Figure 2-2.
3. Connect the other end to your AC power source.
4. Turn on the main power switch at the side of the display (see Figure 2-1). The power indicator lights orange to indicate that the display is in "standby" mode.
5. Press the power button (  ) on the remote control to turn on the display or press the power button (  ) on the keypad.
6. After a brief warm-up period, the display will display an image.





**NOTE** If there's no input signal for a period of time, the display will automatically go into power saving (sleep) mode.



## Changing the OSD Language

The display OSD language is initially set to English, but can also display the menus in different languages.

To change the OSD language:

1. Press MENU.
2. Select Basic Settings from the Main Menu.
3. Select OSD Language from the Basic Settings Menu.
4. Press  or  to select the desired language and press OK. The change takes effect immediately.

## Enabling the Touch Screen

Before setting up your display to support touch screen capability, ensure that:

- Your computer is turned on and connected to the display using the provided USB cable. See Figure 3-7.
- The video output from the computer is connected to a video input on the display. See Figure 3-4, Figure 3-5 or Figure 3-6.
- The display is turned on.

Use the provided USB cable to connect the computer to the USB input on the display as shown in Figure 3-7.

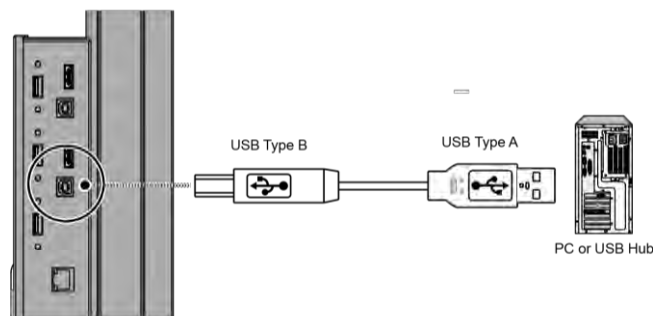

**Figure 3-7. Touch Screen Controller (USB) Connection**



**NOTE**

If the touch screen is not working, please turn off your computer or the display and enabling the touch screen again following the steps above.

## Software Installation

This driver is not needed for any touch functionality, but is needed in order to perform firmware upgrade.

### Automatic Driver Installation

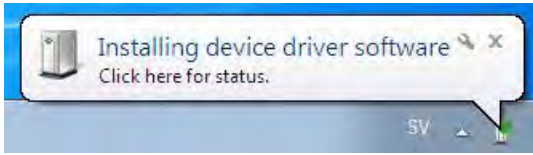

If the automatic driver installation starts, please allow it to run until completion in order to not disrupt the automatic process. Note that the icon may be hidden in the notification area, and that the procedure may take several minutes.

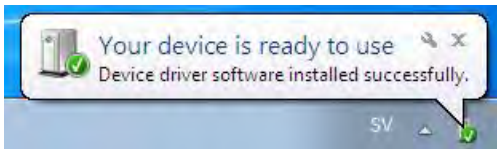

Clicking on the pop-up balloon at this point would show

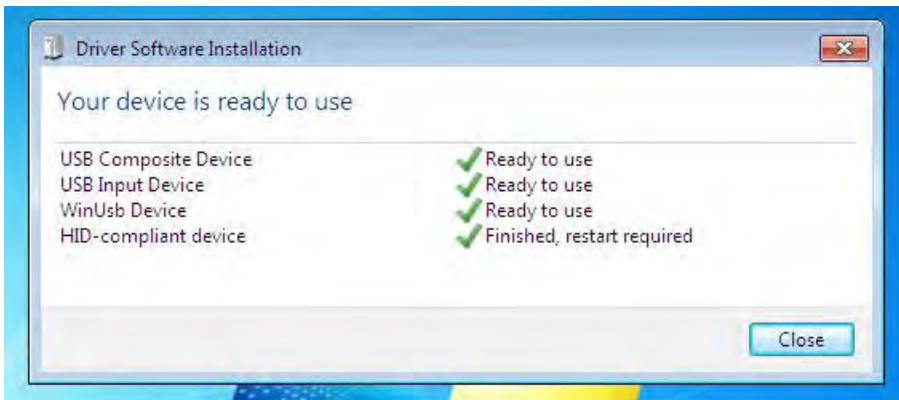

Fully expanded, the view in the Device Manager should look like this (View --> Devices by connection):

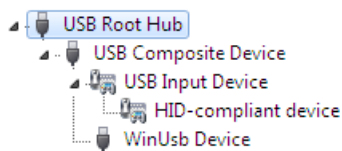

If the automatic installation fails to find the driver, or if automatic driver installation is disabled, or if there is no Internet connection, this is what you will typically see when connecting a FlagFrog touch device.

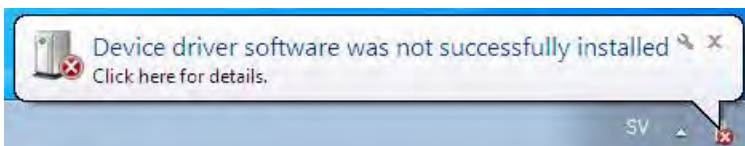

Clicking on the pop-up ballo would show

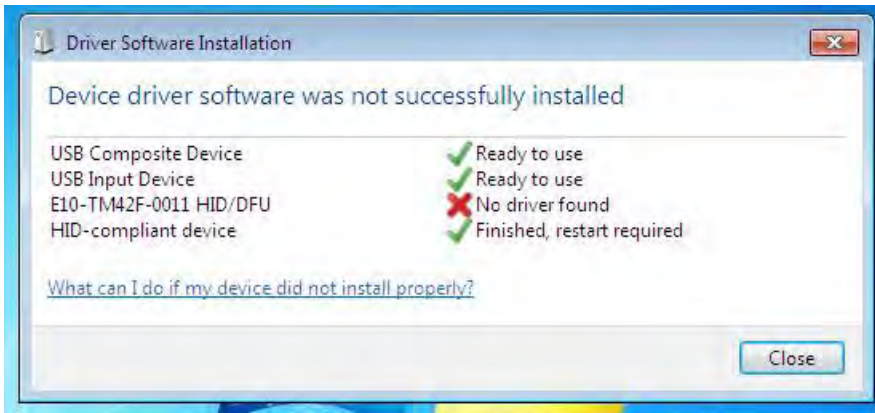

In the Device Manager, the view would be (again, use View --> Devices by connection):

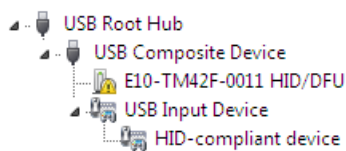

In this case, please proceed with Manual Driver Installation.

### Manual Driver Installation

If the automatic driver installation failed for any of the reasons listed above, or if you would like to install the driver without having a FlatFrog touch device connected to the computer, the driver can be installed manually.

The driver provided with this upgrade package was downloaded from <http://catalog.update.microsoft.com> (requires Internet Explorer) and is called "Microsoft – Other hardware – WinUsb Device" (version 1.1.0.0 from 2012-08-30).

### Manual Driver Installation - Device Connected

1. Extract the firmware upgrade .zip file (right-click --> Extract all...) to the Desktop.
2. Open the Device Manager and locate the "HID/DFU" device with the yellow exclamation mark.
3. Right-click and select "Update Driver Software..."

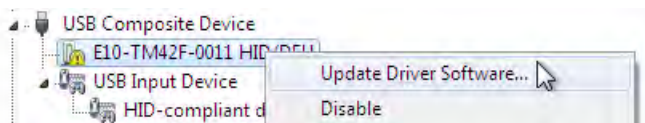



4. Select "Browse my computer for driver software" and select the extracted folder from step 1 and follow the instructions.

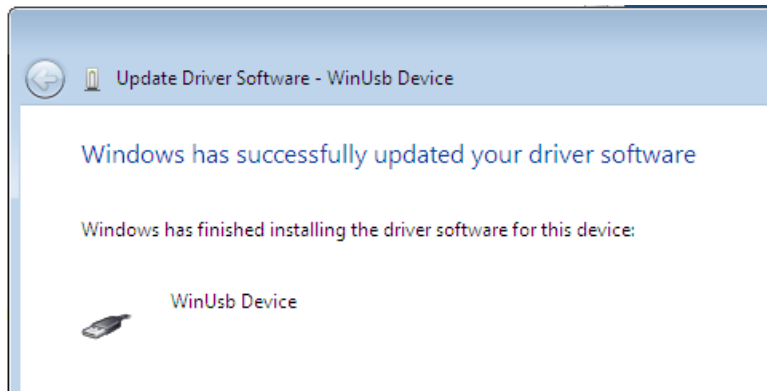

5. If step 4 was unsuccessful, then Windows failed to automatically associate the driver with the device.



6. Choose "Let me pick from a list if device drivers on my computer" in step 4, scroll all the way down to "Universal Serial Bus devices" and click Next.

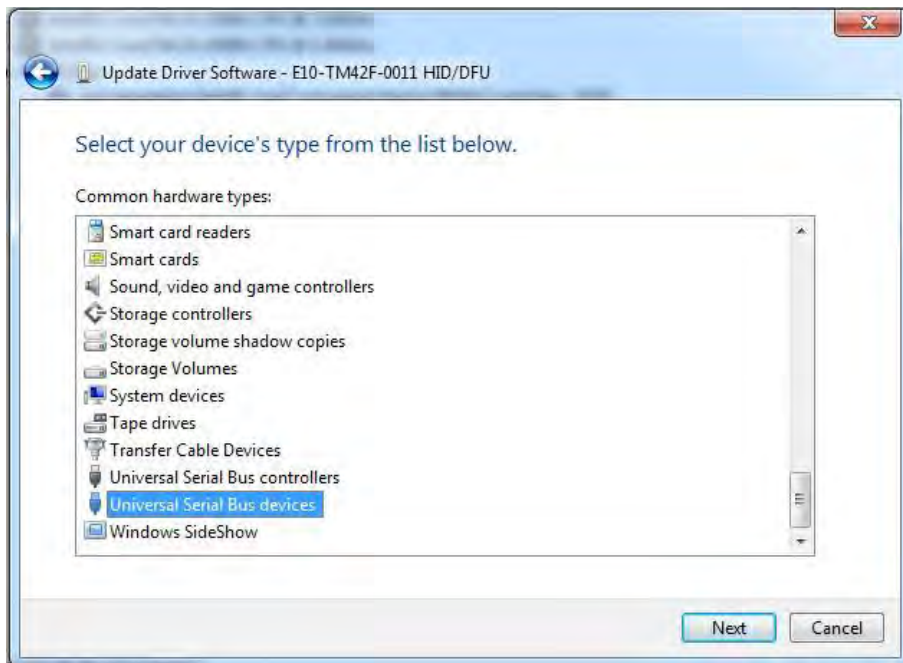

7. Select the WinUsb device driver, and click Next. (If the WinUsb device driver is not in the list, please follow the steps under "Manual Driver Installation - Device Not Connected" first).

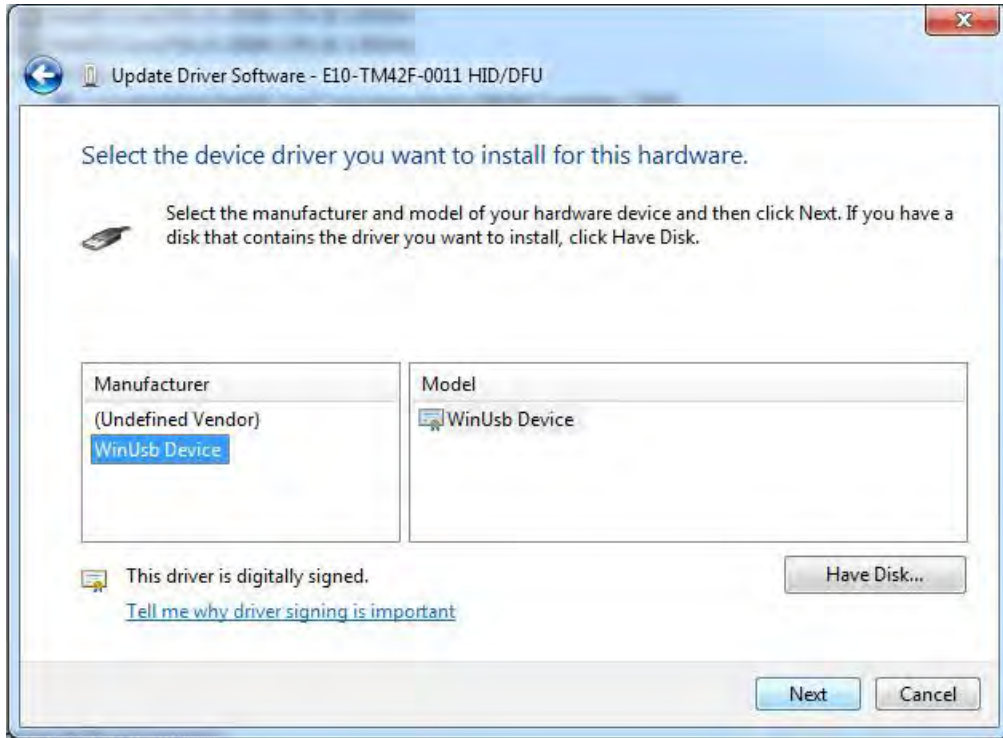

#### Manual Driver Installation - Device Not Connected

1. Extract the firmware upgrade .zip file (right-click --> Extract all...) to the Desktop.
2. Navigate to the "support" folder.
3. Right-click on the install\_driver.bat file and select "Run as administrator" and follow the instructions.

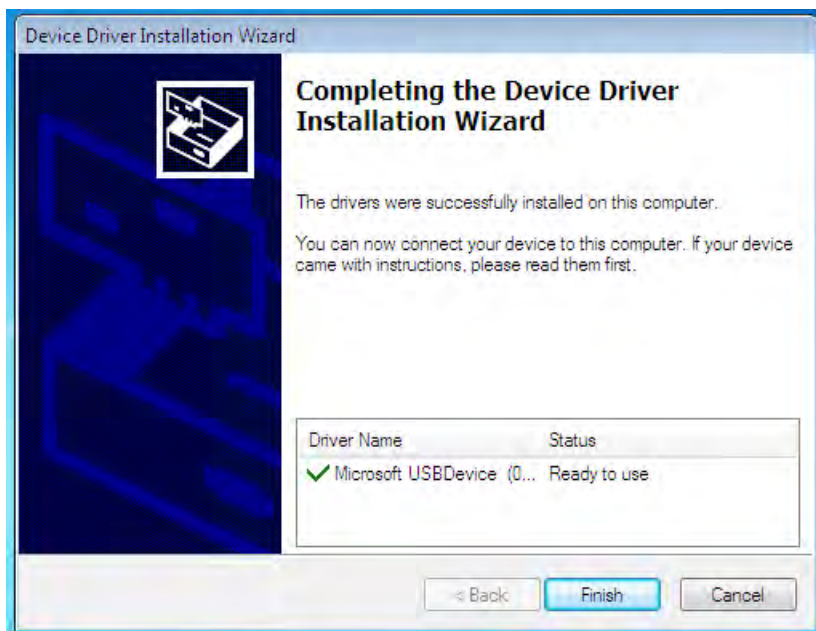

# 4. Operation

## Using the On-Screen Menus

To display the on-screen menus, press MENU on the remote control (Figure 2-3) or built-in keypad (Figure 2-1).

To select a sub-menu, use the ▲ and ▼ buttons to highlight it. Then, press ► to enter that sub-menu.

To select a menu item, use the ▲ and ▼ buttons to highlight it. Then, press ◀ or ▶ to adjust that setting and press OK.

The OSD menus are arranged hierarchically, as shown in Figure 4-1. The default values appear in bold type. Depending on the selected input source and signal characteristics, some menu options may not be available.

Main Menu	SubMenu	Value
Image Settings	Scheme	User, Vivid, Cinema, Game, Sport
	Brightness	0, 1, 2, ..., 50, ...,100
	Contrast	0, 1, 2, ..., 50, ...,100
	Sharpness	0, 1, 2, ..., 50, ...,100
	Saturation	0, 1, 2, ..., 50, ...,100
	Hue	0, 1, 2, ..., 50, ...,100
	Backlight	0, 1, 2, ..., 50, ..., 80, ...,100
	Color Temp & Gamma	Color Temp: 5000K; 6500K; 7500K; 9300K; User
		Gamma: 2.2; off
HDMI RGB Range	Auto; 0-255; 16-235	
Display Settings	Input Source	VGA; DisplayPort; HDMI1; HDMI2; HDMI3; HDMI4; OPS; WPS
	Aspect Ratio	16:9; 4:3; Auto; Point To Point; Letterbox
	OverScan	0% ~ 10%
	Auto Scan	On; Off
	Source Renaming	Rename the input source.
	Auto Adjust	-
	VGA Position	0 ~ 100 (50)
	VGA Phase	0 ~ 255
	VGA Clock	0 ~ 100 (50)
	Home Source	VGA/DisplayPort/HDMI1/HDMI2/HDMI3/HDMI4/OPS/WPS (OPS)
Audio	Volume	0 ~ 100 (50)
	Treble	-10 ~ 10 (0)
	Bass	-10 ~ 10 (0)
	Balance	-10 ~ 10 (0)
	Internal Speaker	On; Off
	Audio Source	USB; Video Source; Aux Input (USB)

Main Menu	SubMenu	Value
Basic Settings	Horizontal Pos.	0 ~ 100 (50)
	Vertical Pos.	0 ~ 100 (50)
	OSD Transparency	0 ~ 4 (0)
	OSD Timeout	5 ~ 60 seconds (30)
	OSD Language	English, French, Spanish, German, Dutch, Swedish, Portuguese, Danish, Italian
	Splash Screen	On; Off
	Power LED	On; Off
	RTC & Schedule	User Mode; Workday Mode; Everyday Mode
Adv. Settings	Smart Light Control	Off; DCR; By Time
	IRFM	On; Off
	Noise Reduction	Off; Low; Medium; High
	Wake Up from Sleep	VGA Only; Digital, RS232, Ethernet, GA; Never Sleep
	EDID Switch	1080p; 4K2K@30; 4K2K@60
	Touch Input Mapping	Auto; WPS; HDMI4; OPS; HDMI3; Rear USB
	Game Mode	On; Off
	Network Configuration	-
	OPS Power State	Follows Display; Always on
	HDMI HDCP	Enable All; Disable HDMI1; Disable HDMI2; Disable HDMI1&2
	Firmware Update (USB)	Yes; No
	Restore Factory Default	Yes; No
Information	Source	Shows the Name of Input Source
	Resolution	Shows the Current Resolution
	Model Name	AVF-8650
	Firmware Version	Shows the Firmware Version of the Monitor
	SubMCU Version	Shows the Firmware Version of the Monitor
	Serial Number	Shows the Serial Number of the Monitor
	Load Default	Yes; No
	Device MAC	Shows the MAC address of the device



NOTE Default settings appear in bold type.

**Figure 4-1. OSD Menu Structure**

## Input Menu

This menu is used for making common image adjustments.

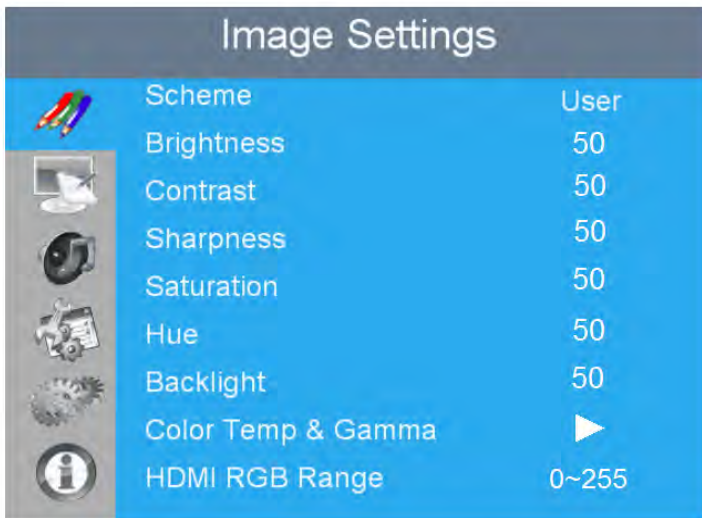

### Scheme

Press ◀ or ▶ to select one of the follows:  
Options: User, Vivid, Cinema, Game, Sport; Default: User

### Brightness

Increase or decrease the brightness of picture.  
Press ◀ or ▶ to select the desired level, and then press OK.  
Range: 0~100; Default: 50

### Contrast

Increase or decrease the contrast of picture.  
Press ◀ or ▶ to select the desired level, and then press OK.  
Range: 0~100; Default: 50

### Saturation

Adjust the brilliance and brightness.  
Press ◀ or ▶ to select the desired level, and then press OK.  
Range: 0~100; Default: 50

Note: This function is not available when displaying PC or graphics sources

### Hue

Increase or decrease the green hue.  
Press ◀ or ▶ to select the desired level, and then press OK.  
Range: 0~100; Default: 50

Note: This function is not available when displaying PC or graphics sources

### Backlight

Increase or decrease the intensity of the LCD backlight.  
Press ◀ or ▶ to select the desired level, and then press OK.  
Range: 0~100; Default: 80

### Color Temp & Gamma

Set Color Temperature and Gamma. See next page.

### HDMI RGB Range

Select an RGB range for the HDMI input.  
Options: Auto, 0-255, 16-235; Default: 0~255

## Colour Temperature Settings

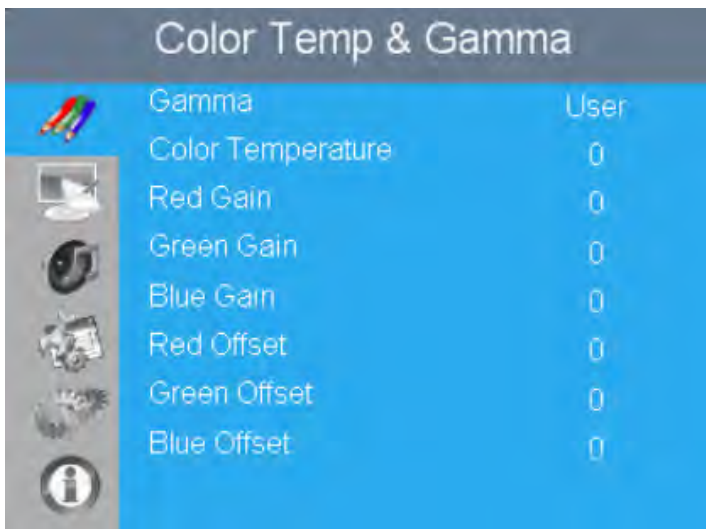

### Gamma

Select gamma curve  
Options: Off, 2.2; Default: 2.2

### Color Temperature

Select a color temperature or select User to make RGB adjustments.  
Options: User, 5000K, 6500K, 7500K and 9300K; Default: 9300K

### Red Gain

Set Color Temperature to "User Mode" to adjust this setting.  
Range: 0-100; Default: 100

### Green Gain

Set Color Temperature to "User Mode" to adjust this setting.  
Range: 0-100; Default: 100

### Blue Gain

Set Color Temperature to "User Mode" to adjust this setting.  
Range: 0-100; Default: 100

### Red Offset

Set Color Temperature to "User Mode" to adjust this setting.  
Range: 0-100; Default: 50

### Green Offset

Set Color Temperature to "User Mode" to adjust this setting.  
Range: 0-100; Default: 50

### Blue Offset

Set Color Temperature to "User Mode" to adjust this setting.  
Range: 0-100; Default: 50

## Display Settings

This menu is used for making general display settings.

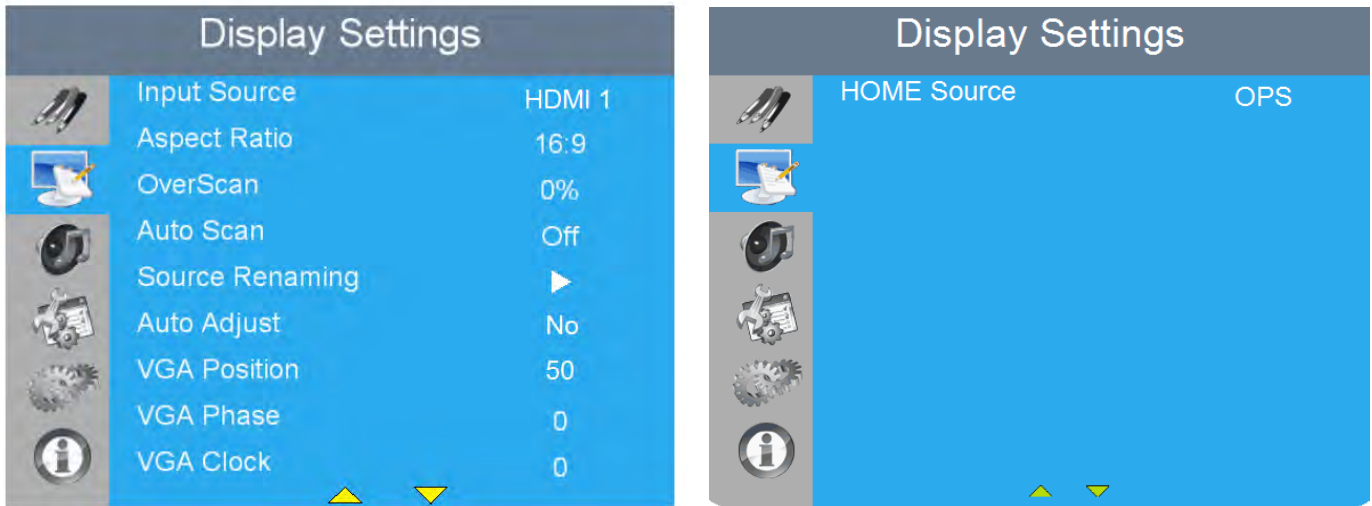

### Input Source

Select the main input source  
Options: VGA; DisplayPort; HDMI1~4; OPS; WPS  
Default: HDMI 1

### Aspect Ratio

Select aspect ratio  
Press ◀ or ▶ to select the aspect ratio, and then press OK.  
Range: 16:9; 4:3; Auto; Point To Point; Letterbox  
Default: 16:9

### OverScan

Adjust the overscan of the image.  
Press ◀ or ▶ to select the desired level, and then press OK.  
Range: 0% ~ 10%; Default: 0%

### Auto Scan

Select whether the display will automatically scan for a main input source  
Options: On, Off; Default: Off

### Source Renaming

Rename the input source.  
Press OK to select the input source you want to rename. Using ▲ or ▼ to change the character and ◀ or ▶ to move forward/back a position. Then press OK button to save the name.

### Auto Adjust

Force the display to reacquire and lock to the input signal (VGA source only). This is useful when the signal quality is marginal.  
Options: No, Yes; Default: No  
Note: This feature does not continually reacquire the signal.

### VGA Position

Adjust the position of the image (VGA source only). Press ◀ or ▶ to select the desired level, and then press OK.  
Range: 0-100; Default: 50

#### VGA Phase

Adjust the phase of the displayed signal (VGA source only). Press ◀ or ▶ to select the desired level, and then press OK.

Range: 0-100

#### VGA Clock

Adjust the clock of the displayed signal (VGA source only). Press ◀ or ▶ to select the desired level, and then press OK.

Range: 0-100

#### HOME Source

Select the input source for the Home source. Press ◀ or ▶ to select the Home source, and then press OK.

Options: VGA/DisplayPort/HDMI1/HDMI2/HDMI3/HDMI4/OPS/WPS

Default: OPS



## Audio Menu

This menu is used for adjusting volume settings.

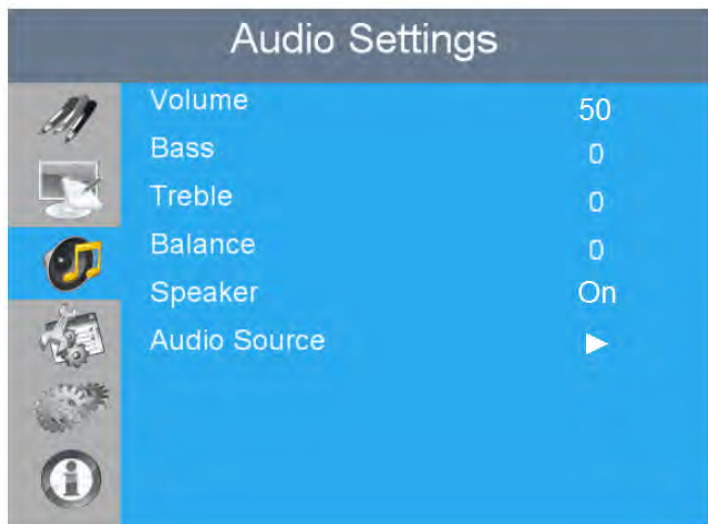

### Volume

Adjust the sound. Press ◀ or ▶ to select the desired level, and then press OK.  
Range: 0-100; Default: 50

### Bass

Adjust the sound in low tones (bass). Press ◀ or ▶ to select the desired level, and then press OK.  
Range: -10-10; Default: 0

### Treble

Adjust the sound in high tones (treble). Press ◀ or ▶ to select the desired level, and then press OK.  
Range: -10-10; Default: 0

### Balance

Adjust the balance of the left and right speakers. Press ◀ or ▶ to select the desired level, and then press OK.  
Range: -10-10; Default: 0

### Speaker

Turn the internal speaker on or off  
Default: On

### Audio Source

Select the audio source for the main input  
Options: USB; Video Source; Aux Input  
Default: USB

## Basic Settings

This menu is used to make basic settings.



### Horizontal Pos.

Adjust the horizontal position of the OSD menu. Press ◀ or ▶ to select the desired level, and then press OK.

Range: 0-100; Default: 50

### Vertical Pos.

Adjust the vertical position of the OSD menu. Press ◀ or ▶ to select the desired level, and then press OK.

Range: 0-100; Default: 50

### OSD Transparency

Adjust the transparency of the OSD menu. Press ◀ or ▶ to select the desired level, and then press OK.

Range: 0-4; Default: 0

### OSD Timeout

Adjust the time in seconds before the OSD menu disappears. Press ◀ or ▶ to select the desired level, and then press OK.

Options: 5s-60s; Default: 30s

### OSD Language

Select the OSD language

Options: English, French, Spanish, German, Dutch, Swedish, Portuguese, Danish, Italian; Default: English

### Splash Screen

Select whether a splash screen appears when the monitor is powered up

Options: On, Off; Default: On

### Power LED

Enable or disable the status LED

Options: On, Off; Default: On

### RTC & Schedule

Set the internal clock of the display, and to power on and off the display at preset times if desired.

Options: User mode, Workday mode, Everyday mode

Default: User mode

## Advanced Settings

This menu is used to make advanced settings.



### Smart Light Control

Enable dynamic contrast (DCR) or ambient light sensor  
Options: Off, DCR, By Time; Default: Off

### IRFM

Create slight frame motion to help avoid image retention  
Options: On, Off; Default: Off

### Noise Reduction

Reduce random noise in the video content  
Options: Off, Low, Medium, High; Default: Off

### Wake Up From Sleep

Options: VGA Only / Digital, RS232, Ethernet, VGA / Never Sleep  
Default: VGA Only

**Note:** VGA Only option is only available when OPS Power State sets to "Follows Display".

### EDID Switch

Select EDID (Extended Display Identification Data) of the HDMI 1-4, OPS, and WPS inputs. Options: 1080p, 4K2K@30, 4K2K@60; Default: 4K2K@60

**Note:** Use the 1080p setting for the broadest support of lower resolution sources. Use 4K2K setting to support high resolution sources such as 3840x2160.

### Touch Input Mapping

Select one of the touch connections or choose auto detection.  
Options: Auto, WPS, HDMI3-4, OPS, Rear USB; Default: Auto

### Game Mode

Select the game mode  
Options: On; Off; Default: On

### Network Configuration

Configures the network settings.

### OPS Power State

Switch the OPS power state.  
Options: Follows Display, Always on; Default: Follows Display

## HDMI HDCP

Select the HDCP Mode

Options: Enable All / Disable HDMI1 / Disable HDMI2 / Disable HDMI1 & 2

Default: Enable All

## Firmware Update (USB)

Plug in the USB flash drive and select Yes to proceed with firmware update.

To start updating firmware, select Yes to continue.

Options: No, Yes

## Restore Factory Reset

Restore all settings to their default value.

Options: No, Yes

## Smart Light Control – By Time

By Time settings allow the user to set the brightness level of the display to a free range in % (between 0-100%) during specific times of the day.

Weekday	Active	BL Saving	Time to Enable	Duration
MON	0	0	0 : 0	0 : 0
TUE	0	0	0 : 0	0 : 0
WED	0	0	0 : 0	0 : 0
THU	0	0	0 : 0	0 : 0
FRI	0	0	0 : 0	0 : 0
SAT	0	0	0 : 0	0 : 0
SUN	0	0	0 : 0	0 : 0

## Wake Up from Sleep

By default, the display will enter power saving (Sleep Mode) if no signal is received for 5 minutes. Normally, the RS-232, DisplayPort, and HDMI inputs are inactive in Sleep Mode, to save power.

To change the behavior of Sleep Mode, change the “Wake up from Sleep” setting in the “Adv. Settings” menu.

- VGA Only (default) – The RS-232, DisplayPort, and HDMI inputs are inactive when the display is in sleep mode. The display will wake up when it receives a signal at the VGA input.
- Digital, RS232, Ethernet, VGA – The RS-232, DisplayPort and HDMI inputs stay active when the display is in sleep mode. The display will wake up when it receives a signal at either of the DisplayPort, HDMI, VGA or RS-232 inputs, or via LAN connection.

## Network Configuration

This menu configures the display's RS232 and Ethernet communication ports.

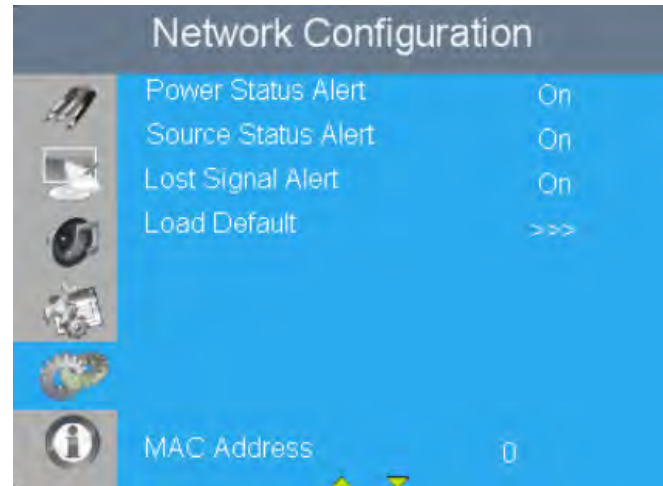
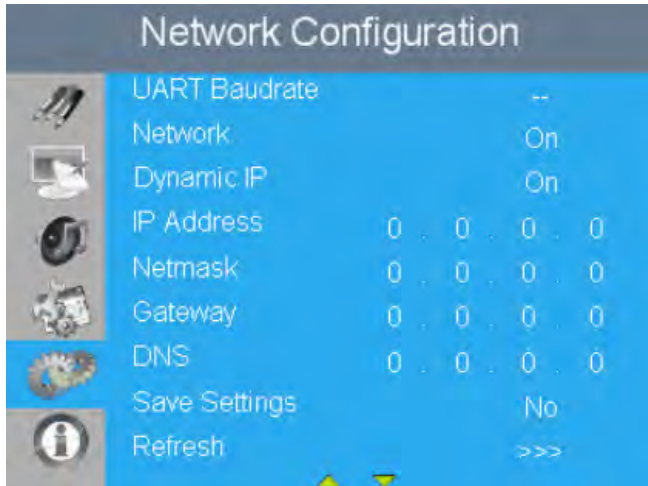

### UART Baudrate

Select the baud rate of the display's RS232 port  
Options: 115200, 38400, 19200, 9600; Default: 115200

### Network

Enable the display's built-in Ethernet port  
Options: No, Yes; Default: No

### IP Address

Enable Dynamic IP mode or set the static IP address of the display's Ethernet port  
Default: 0.0.0.0

### Netmask

Set the subnet mask address.  
Default: 0.0.0.0

### Gateway

Set the Gateway mask address.  
Default: 0.0.0.0

### DNS

Set the DNS mask address.  
Default: 0.0.0.0

### Save Settings

Save the network settings and apply to device.

### Refresh

Refresh dynamic IP information.

### Power Status Alert

Enable an automatic alert when the display is powered down  
Options: On, Off; Default: Off

### Source Status Alert

Enable an automatic alert when the source is changed  
Options: On, Off; Default: Off

Signal Lost Alert	Enable an automatic alert when the video signal is lost Options: On, Off; Default: Off
Load Default	Load default communication settings Options: No, Yes
Device MAC	Display the MAC address of the device.

## Information

This read-only menu provides information on the active source, the latest firmware version, and the serial number.

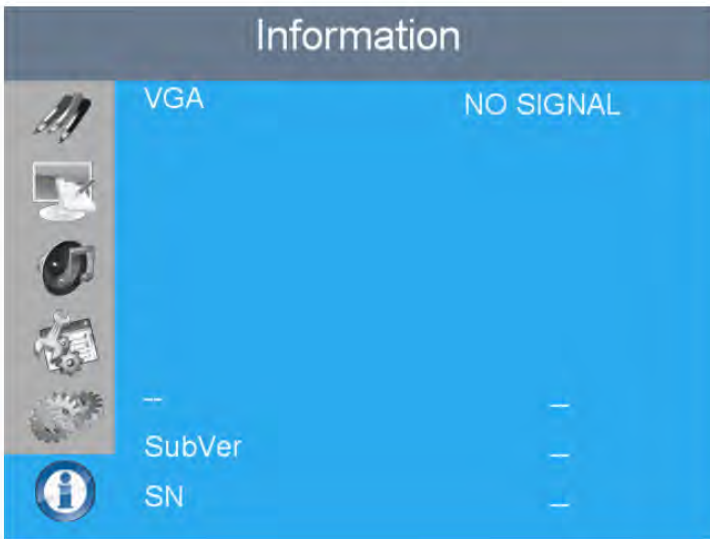

# 5. Maintenance and Troubleshooting

## Maintenance

The Avocor Series LED Display does not require any routine maintenance other than occasional cleaning with a non-abrasive cloth. There are no user-serviceable or replaceable parts. Unless you are a qualified, factory-trained technician, do not attempt to repair or replace any system component yourself. You will void the product warranty if you do so.

## Troubleshooting

Table 5-1 provides some general guidelines for troubleshooting problems you may encounter with the Avocor Series LED Display. If the suggested solutions fail to resolve the problem or if you encounter an issue not described here, please contact your dealer.

Table 5-1. Troubleshooting Chart







Symptom	Possible Cause(s)	Solution
The display does not turn on.	<p>The display is not plugged in or the AC outlet is not active.</p> <p>The main power switch is off.</p> <p>The remote control batteries have run out.</p>	<p>Ensure that the display is plugged in and that the AC outlet is active.</p> <p>Set the main power switch (see Figure 2-1) to the on position.</p> <p>Replace the batteries.</p>
The display is on and menus appear, but there is no picture.	<p>Incorrect source selection.</p> <p>Source component is not turned on.</p> <p>Source component is connected incorrectly or not at all.</p>	<p>Select the correct source.</p> <p>Turn on the source component.</p> <p>Check connections from the source component to the display.</p>
The remote control does not work.	<p>The remote control batteries have run out.</p> <p>The buttons are locked.</p>	<p>Replace the batteries.</p> <p>Unlock the buttons by pressing      and  in sequence.</p>
Image geometry is incorrect.	<p>Incorrect aspect ratio selection.</p>	<p>Select a different aspect ratio.</p>
The display is jittery or unstable.	<p>Poor-quality or improperly connected source.</p> <p>The horizontal or vertical scan frequency of the input signal may be out of range for the display.</p>	<p>Ensure that the source is properly connected and of adequate quality for detection.</p> <p>Correct at the source.</p>

Table 5-1. Troubleshooting Chart (continued)

Symptom	Possible Cause(s)	Solution
Image is too bright and / or lacks definition in the bright areas of the image.	Contrast is set too high.	Decrease the contrast setting.
Image <b>appears "washed out"</b> and / or dark areas appear too bright.	Brightness is set too high.	Decrease the brightness setting.
Image is too dark.	Brightness and / or Backlight are set too low.	Increase the brightness and / or backlight settings.
Images from an HDMI source do not display.	The resolution and frequency of the video card in the computer are not compatible with the display.  HDMI cable from source to display is either defective or too long.	Select a compatible resolution and vertical frequency (refer to Supported Timings on page 59).  Try a known-good and / or shorter HDMI cable.
Computer images do not display correctly.	The resolution and frequency of the video card in the computer are not compatible with the display  Clock and Phase settings need adjustment.	Select a compatible resolution and vertical frequency (refer to Supported Timings on page 59).  Adjust Clocks and Phase settings (refer to Display Settings page 39).
<b>Touch screen doesn't work.</b>	Multi-touch controller host computer is not connected correctly.  Host computer hardware or OS incompatibility.	See Figure 3-7.  Refer to Enabling the Touch Screen on page 30.



Should you require assistance with a suspected hardware fault, please contact the support line below. You will require your unit serial number. The operator will attempt to diagnose any fault and will take action as appropriate.

The Avocor logo is displayed in a large, bold, black sans-serif font. A vertical line is positioned to the right of the logo, separating it from the contact information.

## Warranty Support

UK & EMEA. Tel +44 (0) 1276 804 654 - [service@avocor.co.uk](mailto:service@avocor.co.uk)

US & ROW. Tel. 855-268-7999 - [service@avocor.com](mailto:service@avocor.com)

## 6. External Control

In addition to using the display keypad or remote control unit, you can control the display using a serial (RS232) link to send Hexadecimal commands and receive responses to those commands. (ASCII is not accepted/used).

You also use discrete infrared (IR) control codes to program a third-party remote control unit. For more information, refer to Using Discrete IR Codes on page 57.

### Serial Communications

The display uses a simple text-based control protocol to take requests from control devices and to provide responses to such devices. This section describes how to send control messages over a serial link between the display and an automation/control system or a PC running a terminal emulation program such as Windows® HyperTerminal or Tera Term.

#### RS232 Connection and Port Configuration

Connect your control system or PC to the RS232 input of the display as shown in Figure 3-2.

Configure the RS232 controller or PC serial port as follows: no parity, 8 data bits, 1 stop bit and no flow control. Set the baud rate to 115200, to match that of the display RS232 port.

#### Command and Response Format

Commands sent from an automation/control system or PC to the display must have the following format:

```
[STX] [IDT] [TYPE] [CMD] ([VALUE] or [REPLY]) [ETX] [CR]
```

Where:

- [STX] indicates the start of the command data (always 07).
- [IDT] is the display ID (always 01).
- [TYPE] is the command type:
  - 00 = return to host (response from the LCD panel)
  - 01 = read / action
  - 02 = write
- [VALUE] is the parameter setting for the command.
- [REPLY] is the parameter setting for the command, acknowledged by the display in its response to a command.
- [ETX] indicates the end of the command data (always 08).
- [CR] is the ASCII carriage return key (0x0D).

## Command and Response Examples

Here are some examples of Hexadecimal serial commands and their responses:

Table 6-1. Serial Command/ Response Examples

Description	Command sent to LCD Panel	Response Received from LCD Panel
Turn LCD panel power off.	07 01 02 50 4F 57 00 08	07 01 00 50 4F 57 00 08
Turn LCD panel power on.	07 01 02 50 4F 57 01 08	07 01 00 50 4F 57 01 08
Request LCD panel power status.	07 01 01 50 4F 57 08	07 01 00 50 4F 57 XX 08 (XX = 0 when off or 1 when on)
Set the LCD panel contrast to 30 (1E hex).	07 01 02 43 4F 4E 1E 08	07 01 00 43 4F 4E 1E 08
Reset the LCD panel display settings.	07 01 02 41 4C 4C 00 08	07 01 00 41 4C 4C 00 08
Request LCD panel serial number.	07 01 01 53 45 52 08	07 01 00 53 45 52 S(0)...S(12) 08 S(0) ...S(12) = the serial number in ASCII
Request LCD panel firmware version.	07 01 01 47 56 45 08	07 01 00 47 56 45 S(0)...S(5) 08 S(0)...S(5) = the firmware version in ASCII

## Serial Command List

Table 6-2 lists all supported commands.

Table 6-2. Serial Commands

Main Item	Control Item	Type	CMD (HEX)	Value (HEX)	Reply (HEX)	Content	CMD (ASCII)
Power Control and Input Source	Power Control	W/R	50 4F 57	0	0	Off (soft power)	POW
				1	1	On (soft power)	
	Signal State	R	50 4F 53	-	0	Signal	POS
				-	1	No signal	
	IPC Control	W/R	49 50 43	0	0	Off	IPC
				1	1	On	
	OPS Power State	W/R	4F 41 50	0	0	Follows display	OAP
				1	1	Always on	
	Input Source	W/R	4D 49 4E	0	0	VGA	MIN
				9	9	HDMI 1	
0A				0A	HDMI 2		
0B				0B	HDMI 3		
0C				0C	HDMI 4		
0D				0D	DisplayPort		
0E				0E	IPC/OPS		
13				13	WPS		
Display Adjustment	Display Adjustment	W/R	42 52 49	00~64	00~64	Back Light Brightness	BRI
		W/R	42 52 4C	00~64	00~64	Digital Brightness Level	BRL
		W/R	42 4C 43	0	0	Off (Back Light)	BLC
						1	
		W/R	43 4F 4E	00~64	00~64	Contrast	CON
		W/R	48 55 45	00~64	00~64	Hue	HUE
		W/R	53 41 54	00~64	00~64	Saturation	SAT
		W/R	4E 4F 52	0	0	Noise Reduction: Off	NOR
				1	1	Noise Reduction: Low	
				2	2	Noise Reduction: Medium	
3	3			Noise Reduction: High			
W/R	55 53 52	00~64	00~64	Red Gain (mapping 0~100)	USR		

Main Item	Control Item	Type	CMD (HEX)	Value (HEX)	Reply (HEX)	Content	CMD (ASCII)
Display Adjustment	Display Adjustment	W/R	55 53 47	00~64	00~64	Green Gain (mapping 0~100)	USG
		W/R	55 53 42	00~64	00~64	Blue Gain (mapping 0~100)	USB
		W/R	55 4F 52	00~64	00~64	Red Offset (mapping 0~100)	UOR
		W/R	55 4F 47	00~64	00~64	Green Offset (mapping 0~100)	UOG
		W/R	55 4F 42	00~64	00~64	Blue Offset (mapping 0~100)	UOB
		W/R	43 4F 54	0	0	User	COT
				1	1	6500K	
				2	2	9300K	
				6	6	5000K	
		W/R	47 41 43	0	0	Gamma Off	GAC
	1			1	Gamma 2.2		
	VGA Adjustment	W/R	50 48 41	00~FF	00~FF	Phase	PHA
		W/R	43 4C 4F	00~64	00~64	Clock	CLO
		R/W	48 4F 52	00~64	00~64	Horizontal Position	HOR
		R/W	56 45 52	00~64	00~64	Vertical Position	VER
		W	41 44 4A	0	0	Auto Adjust	ADJ
	Sharpness	W/R	53 48 41	00~64	00~64	Sharpness	SHA
Other Control	Scaling	W/R	41 53 50	0	0	Main Window Aspect Ratio Native (PointToPoint)	ASP
				1	1	Full Screen (16:9)	
				2	2	Pillarbox (4:3)	
				3	3	Letterbox	
		W/R	5A 4F 4D	00~0A	00~0A	Adjust overscan ratio	ZOM
	Baudrate Adjustment	W/R	42 52 41	0	0	115200	BRA
				1	1	38400	
				2	2	19200	
				3	3	9600	
	Other Control	W	52 43 55	0	0	MENU Key	RCU
				1	1	INFO Key	
				2	2	UP Key	
				3	3	DOWN Key	
				4	4	LEFT Key	
				5	5	RIGHT Key	
				6	6	OK Key	
				7	7	EXIT Key	
				8	8	VGA Key	
				0A	0A	HDMI1 Key	
				0B	0B	HDMI2 Key	
				17	17	SCALING Key	
				18	18	FREEZE Key	
				19	19	MUTE Key	
				1A	1A	BRIGHT Key	
	1B	1B	CONTRAST Key				
	1C	1C	AUTO Key				
	1D	1D	VOLUME+ Key				
1E	1E	VOLUME- Key					

Main Item	Control Item	Type	CMD (HEX)	Value (HEX)	Reply (HEX)	Content	CMD (ASCII)	
Other Control	Other Control	W	52 43 55	1F	1F	HDMI3 Key	RCU	
				21	21	OPS Key		
		W	41 4C 4C	0	0	Reset all	ALL	
				1	1	Reset all but communication (RS232, LAN)		
		W/R	4B 4C 43	0	0	Un-lock keys	KLC	
				1	1	Lock keys		
		R	53 45 52		13 bytes	Read Serial Number	SER	
		R	4D 4E 41		13 bytes	Read Model Name	MNA	
		R	47 56 45		6 bytes	Read Firmware Version	GVE	
		R	52 54 56		Current value	Read RS232 table Version	RTV	
		W	47 56 53	0	[00]+5 byte	Querying main scaler version	GVS	
				1	[00]+5 byte	Querying sub mcu version		
				2	[00]+5 byte	Querying network module version		
		Audio	Audio	W/R	56 4F 4C	00~64	00~64	volume
	W/R			42 41 53	00~14	00~14	Bass (-10~10)	BAS
	W/R			54 52 45	00~14	00~14	Treble (-10~10)	TRE
	W/R			42 41 4C	00~14	00~14	Bass (-10~10)	BAL
	W/R			49 4E 53	0	0	Internal Speaker Off	INS
					1	1	Internal Speaker On	
	W/R			4D 55 54	0	0	Mute Off	MUT
					1	1	Mute On	
	W/R	56 4F 49	05~1E	-	VOLUME + Value	VOI		
	W/R	56 4F 44	05~1E	-	VOLUME - Value	VOD		
	Scheme selection	Scheme selection	W/R	53 43 4D	0	0	User	SCM
					1	1	Sport	
					2	2	Game	
					3	3	Cinema	
					4	4	Vivid	
Other Control	EcoMode WakeUpFromSleep	W/R	57 46 53	0	0	Set VGA_ONLY	WFS	
				1	1	Set DIGITAL, RS232, Ethernet		
				2	2	Set Never Sleep		
	RTC	RTC	W/R	52 54 59	00~63	00~63	Set Real time Year	RTY
					01~0C	01~0C	Set Real time Month	RTM
					01~1F	01~1F	Set Real time Day	RTD
					00~17	00~17	Set Real time Hour	RTH
					00~3B	00~3B	Set Real time Minute	RTN
			W/R	54 4D 53	0	0	Same Settings on All (Everyday)	TMS
					1	1	Same Settings on Work Days (Workday)	
					2	2	User	
			W/R	41 45 4E	1	1	Sunday Alarm Enable (Note 14)	AEN
					2	2	Monday Alarm Enable (Note 14)	
					4	4	Tuesday Alarm Enable (Note 14)	

Main Item	Control Item	Type	CMD (HEX)	Value (HEX)	Reply (HEX)	Content	CMD (ASCII)		
Other Control	RTC	W/R	41 45 4E	8	8	Wednesday Alarm Enable (Note 14)	AEN		
				10	10	Thursday Alarm Enable (Note 14)			
				20	20	Friday Alarm Enable (Note 14)			
				40	40	Saturday Alarm Enable (Note 14)			
		W/R	41 45 46	1	1	Sunday Alarm Disable (Note 14)	AEF		
				2	2	Monday Alarm Disable (Note 14)			
				4	4	Tuesday Alarm Disable (Note 14)			
				8	8	Wednesday Alarm Disable (Note 14)			
				10	10	Thursday Alarm Disable (Note 14)			
				20	20	Friday Alarm Disable (Note 14)			
				40	40	Saturday Alarm Disable (Note 14)			
		W/R	4E 4E 48	00~17	00~17	Monday On Hour	NNH		
		W/R	4E 4E 4D	00~3B	00~3B	Monday On Minute	NNM		
		W/R	4E 46 48	00~17	00~17	Monday Off Hour	NFH		
		W/R	4E 46 4D	00~3B	00~3B	Monday Off Minute	NFM		
		W/R	45 4E 48	00~17	00~17	Tuesday On Hour	ENH		
		W/R	45 4E 4D	00~3B	00~3B	Tuesday On Minute	ENM		
		W/R	45 46 48	00~17	00~17	Tuesday Off Hour	EFH		
		W/R	45 46 4D	00~3B	00~3B	Tuesday Off Minute	EFM		
		W/R	44 4E 48	00~17	00~17	Wednesday On Hour	DNH		
		W/R	44 4E 4D	00~3B	00~3B	Wednesday On Minute	DNM		
		W/R	44 46 48	00~17	00~17	Wednesday Off Hour	DFH		
		W/R	44 46 4D	00~3B	00~3B	Wednesday Off Minute	DFM		
		W/R	55 4E 48	00~17	00~17	Thursday On Hour	UNH		
		W/R	55 4E 4D	00~3B	00~3B	Thursday On Minute	UNM		
		W/R	55 46 48	00~17	00~17	Thursday Off Hour	UFH		
		W/R	55 46 4D	00~3B	00~3B	Thursday Off Minute	UFM		
		W/R	49 4E 48	00~17	00~17	Friday On Hour	INH		
		W/R	49 4E 4D	00~3B	00~3B	Friday On Minute	INM		
		W/R	49 46 48	00~17	00~17	Friday Off Hour	IFH		
		W/R	49 46 4D	00~3B	00~3B	Friday Off Minute	IFM		
		W/R	54 4E 48	00~17	00~17	Saturday On Hour	TNH		
		W/R	54 4E 4D	00~3B	00~3B	Saturday On Minute	TNM		
		W/R	54 46 48	00~17	00~17	Saturday Off Hour	TFH		
		W/R	54 46 4D	00~3B	00~3B	Saturday Off Minute	TFM		
		W/R	53 4E 48	00~17	00~17	Sunday On Hour	SNH		
		W/R	53 4E 4D	00~3B	00~3B	Sunday On Minute	SNM		
		W/R	53 46 48	00~17	00~17	Sunday Off Hour	SFH		
		W/R	53 46 4D	00~3B	00~3B	Sunday Off Minute	SFM		
			Auto Scan	W/R	41 54 53	0	0	Off	ATS
						1	1	Main	
			IRFM	W/R	49 52 46	0	0	Off	IRF
						1	1	On	

Main Item	Control Item	Type	CMD (HEX)	Value (HEX)	Reply (HEX)	Content	CMD (ASCII)
Other Control	Smart Light Control	W/R	53 4C 43	0	0	Off	SLC
				1	1	DCR	
				3	3	By time	
	Power LED	W/R	4C 45 44	0	0	Off	LED
				1	1	On	
	HDMI EDID	W/R	45 44 48	0	0	4Kx2K	EDH
				1	1	1080P	
	DisplayPort EDID	W/R	45 44 50	0	0	4Kx2K	EDP
				1	1	1080P	
	HDMI RGB Color Range	W/R	48 43 52	0	0	Auto Detect	HCR
				1	1	0-255	
				2	2	16-235	
	HDMI HDCP	W/R	48 44 43	0	0	Enable All	HDC
				1	1	Disable HDMI 1 & 2	
				2	2	Disable HDMI1	
				3	3	Disable HDMI2	
	Touch Control	W/R	54 4F 43	0	0	Auto (Read Only)	TOC
				1	1	OPS	
				2	2	External Touch1 (HDMI3)	
				3	3	External Touch 2 (Rear USB)	
				4	4	MiniPC(HDMI4)	
5				3	WPS		
OSD Control	Transparency	W/R	4F 53 54	00-04	00-04	OSD Transparency	OST
	H Position	W/R	4F 53 48	00-64	00-64	OSD H Position	OSH
	V Position	W/R	4F 53 56	00-64	00-64	OSD V Position	OSV
	OSD Language	W/R	4F 53 4C	0	0	English	OSL
				1	1	French	
				2	2	German	
				3	3	Dutch	
				08	08	Danish	
				0D	0D	Italian	
				0E	0E	Swedish	
				0F	0F	Portuguese	
10	10	Spanish					
OSD Timeout	W/R	4F 53 4F	05-3C	05-3C	OSD Timeout (5, 10, 20, 30, 60 sec)	OSO	
Ethernet Setup	Network Enable	W/R	4E 57 45	0	0	No	NWE
				1	1	Yes	
	Dynamic IP	W/R	44 49 50	0	0	Disable	DIP
				1	1	Enable	
	Default	W	4C 44 53	0	0	Load network default settings (It will take about 15 seconds.)	LDS
	E-Mail Alert	W/R	50 53 41	0	0	Off (Power Status Alert)	PSA
				1	1	On (Power Status Alert)	
		W/R	53 53 41	0	0	Off (Source Status Alert)	SSA
				1	1	On (Source Status Alert)	
W/R	53 4C 41	0	0	Off (Signal Lost Alert)	SLA		
		1	1	On (Signal Lost Alert)			

Main Item	Control Item	Type	CMD (HEX)	Value (HEX)	Reply (HEX)	Content	CMD (ASCII)
Ethernet Setup	Static IP Settings	W/R	49 50 31	00~FF	00~FF	Static IP Address 1	IP1
		W/R	49 50 32	00~FF	00~FF	Static IP Address 2	IP2
		W/R	49 50 33	00~FF	00~FF	Static IP Address 3	IP3
		W/R	49 50 34	00~FF	00~FF	Static IP Address 4	IP4
		W/R	4D 4B 31	00~FF	00~FF	Subnet Mask 1	MK1
		W/R	4D 4B 32	00~FF	00~FF	Subnet Mask 2	MK2
		W/R	4D 4B 33	00~FF	00~FF	Subnet Mask 3	MK3
		W/R	4D 4B 34	00~FF	00~FF	Subnet Mask 4	MK4
		W/R	47 57 31	00~FF	00~FF	Gateway 1	GW1
		W/R	47 57 32	00~FF	00~FF	Gateway 2	GW2
		W/R	47 57 33	00~FF	00~FF	Gateway 3	GW3
		W/R	47 57 34	00~FF	00~FF	Gateway 4	GW4
		W/R	46 44 31	00~FF	00~FF	DNS Address 1	FD1
		W/R	46 44 32	00~FF	00~FF	DNS Address 2	FD2
		W/R	46 44 33	00~FF	00~FF	DNS Address 3	FD3
		W/R	46 44 34	00~FF	00~FF	DNS Address 4	FD4
		W	53 4E 53	0	0	Save Network Settings	SNS
		W	4D 41 43	00~05	00~FF	Querying MAC ID #0~#5	MAC



## Using Discrete IR Codes

The display accepts commands in the form of infrared (IR) signals that conform to the NEC protocol. Each display remote control button has an IR control code associated with it.

You can use these codes to program a third-party, "universal" remote control unit to work with the display. These third-party products usually come with a computer software application for this purpose. For more information, consult the documentation provided with the remote control unit.

### IR Command Protocol

The IR control codes have the following characteristics:

Each code consists of the following:

- A leader pulse (a modulated pulse of 9 ms followed by a non-modulated pulse of 4.5 ms);
- 16 address bits (also called a "custom code"): eight (8) bits for the address followed by the logical inverse of the address. The custom code for the display is 16559 decimal (0x40AF, binary 01000000 10101111).
- 16 data bits: eight (8) bits for the command followed by the logical inverse of the command
- An end pulse (a modulated pulse of 0.56 ms, similar to the modulated pulse in the '0' and '1' bits). The end of the modulated pulse constitutes the end of the data transmission.

The carrier frequency is 38 kHz, with the modulated pulses having a 33% duty cycle.

Commands are sent at a maximum rate of 9 Hz.

For example, here is the NEC control code for the POWER button on the display remote control unit:

Hex	40	AF	1C	E3
Binary	01000000	10101111	00011100	11100011
Function	Cust. Code Byte 1	Cust. Code Byte 2	Command	Command (Logical Inverse)

### IR Control Code List

Table 6-3 lists the IR control codes for the display.

Table 6-3. Infrared (IR) Control Codes

No.	Customer Code	Data Code	Function
1	40AF	1CE3	POWER
2	40AF	15EA	HOME/OPS
3	40AF	0FF0	SOURCE
4	40AF	02FD	UP
5	40AF	01FE	LEFT
6	40AF	03FC	RIGHT
7	40AF	19E6	DOWN
8	40AF	12ED	OK
9	40AF	05FA	EXIT
10	40AF	1BF4	Volume -
11	40AF	1DE2	Volume +
12	40AF	0EF1	MENU

# 7. Specifications

Table 7-1 lists the signal types supported by each input on the AVF-8650 display.

PANEL	
Diagonal Size (Inch)	86"
Backlight	Direct LED
Aspect Ratio	16:9
Input Resolution	3840 x 2160 @ 60 Hz
Response Time	8 (ms)
Brightness	300 (cd/m <sup>2</sup> )
Contrast Ratio	1200:1
Viewing Angle	178° (H) / 178° (V)
Supported Colors	1.07G colors
Display Orientation	Landscape compatible
TOUCH SYSTEM	
Interface	Touch USB
Touch	High-resolution inGlass™ touch; Up to 20 points
Glass	Chemically strengthened glass with G2&AF finish; 0.1-inch/2mm thickness
Supported Operating System	Windows 7 / 8 / 10; Mac OS 10
AUDIO	
Built-in Speakers	4 KΩ / 2 x 15W
CONNECTIVITY	
Connections	5x HDMI 2.0 / 1 x VGA / 1 x DisplayPort 1.2 / 1 x HDMI Out
Audio	Audio In / Audio Out / SPDIF Out
Control	1x Touch USB 3.0 HUB / 3 x Touch USB 2.0 / RS232 / Ethernet
PHYSICAL SPECIFICATIONS	
Dimensions	80.2 x 49.1 x 4.0 (in) / 2,038 x 1,247 x 102.8(mm)
Weight	Net: 73.5 kg / Gross: 88 kg
Wall Mount	31.5 x 15.7 (in) / 800 x 400(mm)
MiniPC Mount	75 x 75, 100 x 100 (mm) / 2.9 x 2.9, 3.9 x 3.9 (in)
Fanless Design	Yes
OSD FUNCTIONS	
OSD Languages	English, French, German, Dutch, Danish, Italian, Swedish, Portuguese, Spanish
Source Auto Detect Function	Yes
POWER	
Power Supply	AC100-240V (Worldwide), Max 5A, 50/60Hz
Maximum Power Consumption	380 W
Standby	≤0.5 W
ENVIRONMENTAL	
Operating Temperature	0 °C ~ 40 °C
Storage Temperature	-20 °C ~ 60 °C
Humidity	30% ~ 85%

## Supported Timings

Table 7-2 lists the signal types supported by each input on the display.

Table 7-2. Supported Timings By Input

Timing		fH (kHz)	fV (Hz)	Dot clock (MHz)	HDMI	VGA	DisplayPort	
VESA	VGA 640x480	31.469	59.94	25.175	○	○	○	
		37.861	72.809	31.5	○	○	○	
		37.5	75	31.5	○	○	○	
	SVGA 800x600	35.156	56.25	36	○	○	○	
		37.879	60.317	40	○	○	○	
		48.077	72.188	50	○	○	○	
	XGA 1024x768	46.875	75	49.5	○	○	○	
		48.363	60.004	65	○	○	○	
		56.476	70.069	75	○	○	○	
		60.023	75.029	78.75	○	○	○	
		WXGA1366x768	47.712	59.79	85.5	○	○	○
	1280 x 720	44.444	59.98	64	-	○	○	
		44.772	59.86	74.5	-	○	○	
		56.456	74.78	95.75	-	-	○	
	1280 x 768	47.776	59.87	79.5	-	-	○	
		47.396	59.995	68.25	-	-	○	
	1280 x 800	49.306	59.91	71	○	○	○	
		49.702	59.81	83	○	○	○	
	SXGA	1152x864	67.5	75	108	○	○	○
			63.981	60.02	108	○	○	○
		1280x1024	79.976	75.025	135	○	○	○
	1440 x 900	55.469	59.901	88.75	-	-	○	
		55.935	59.88	106.5	○	○	○	
WSXGA+ 1680 x1050	64.674	59.883	119	○	○	○		
	65.29	59.954	146.25	○	○	○		
UXGA 1600 x 1200	75	60	162	○	○	○		
1920 x 1080	66.587	59.93	138.5	-	○	○		
WUXA 1920 x 1200	74.038	59.95	154	-	○	○		
QHD 2560x1440	88.787	59.951	241.5	○	-	○		
QSXGA 2560x1600	98.713	59.972	268.5	○	-	○		
EDTV	480p	31.5	60	27.03	○	-	○	
	576p	31.25	50	27	○	-	○	
HDTV	720p	37.5	50	74.25	○	-	○	
	1280x720	44.995	59.94	74.176	○	-	○	
		45	60	74.25	○	-	○	
	1080i	28.13	50	74.25	○	-	○	
	1920x1080	33.716	59.94	74.176	○	-	○	
		33.75	60	74.25	○	-	○	
	1080p 1920x1080	27	24	74.25	○	-	○	
		28.125	25	74.25	○	-	○	
		33.75	30	74.25	○	-	○	
		56.25	50	148.5	○	-	○	
67.433		59.94	148.352	○	-	○		
67.5	60	148.5	○	-	○			

Timing		fH (kHz)	fV (Hz)	Dot clock (MHz)	HDMI	VGA	DisplayPort
4K2K	3840x2160	54	24	297	○	-	○
		56.25	25	297	○	-	○
		67.5	30	297	○	-	○
		112.5	50	594	○	-	○
		133.313	59.997	533.25	○	-	○
		135	60	594	○	-	○

# Overall Dimensions

Figure 7-1 shows the display dimensions of AVF-8650 (all dimensions are in inches).

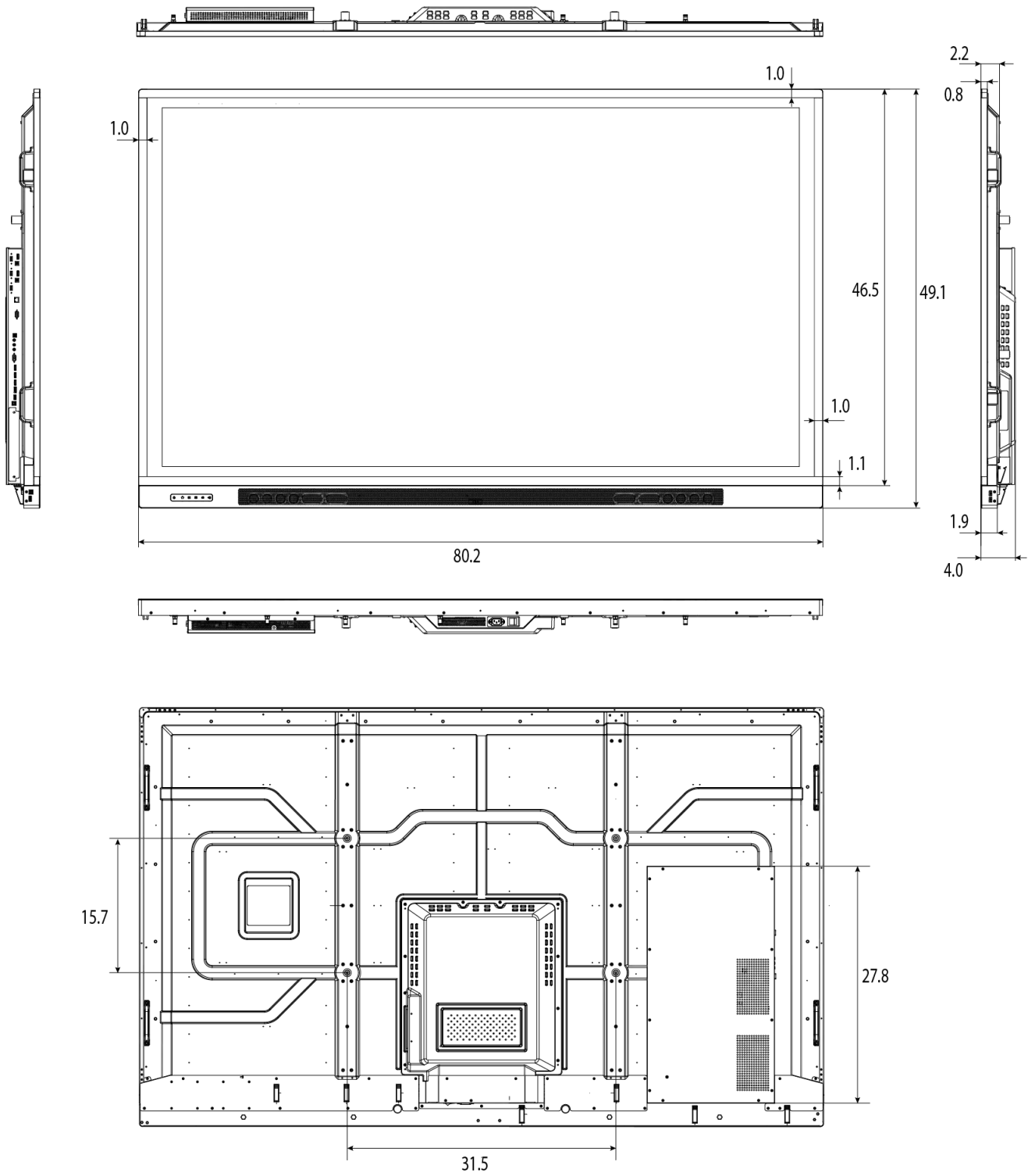

**Figure 7-1. AVF-8650 Display Dimensions (inch)**

Figure 7-2 shows the display dimensions of AVF-8650 (all dimensions are in millimeters).

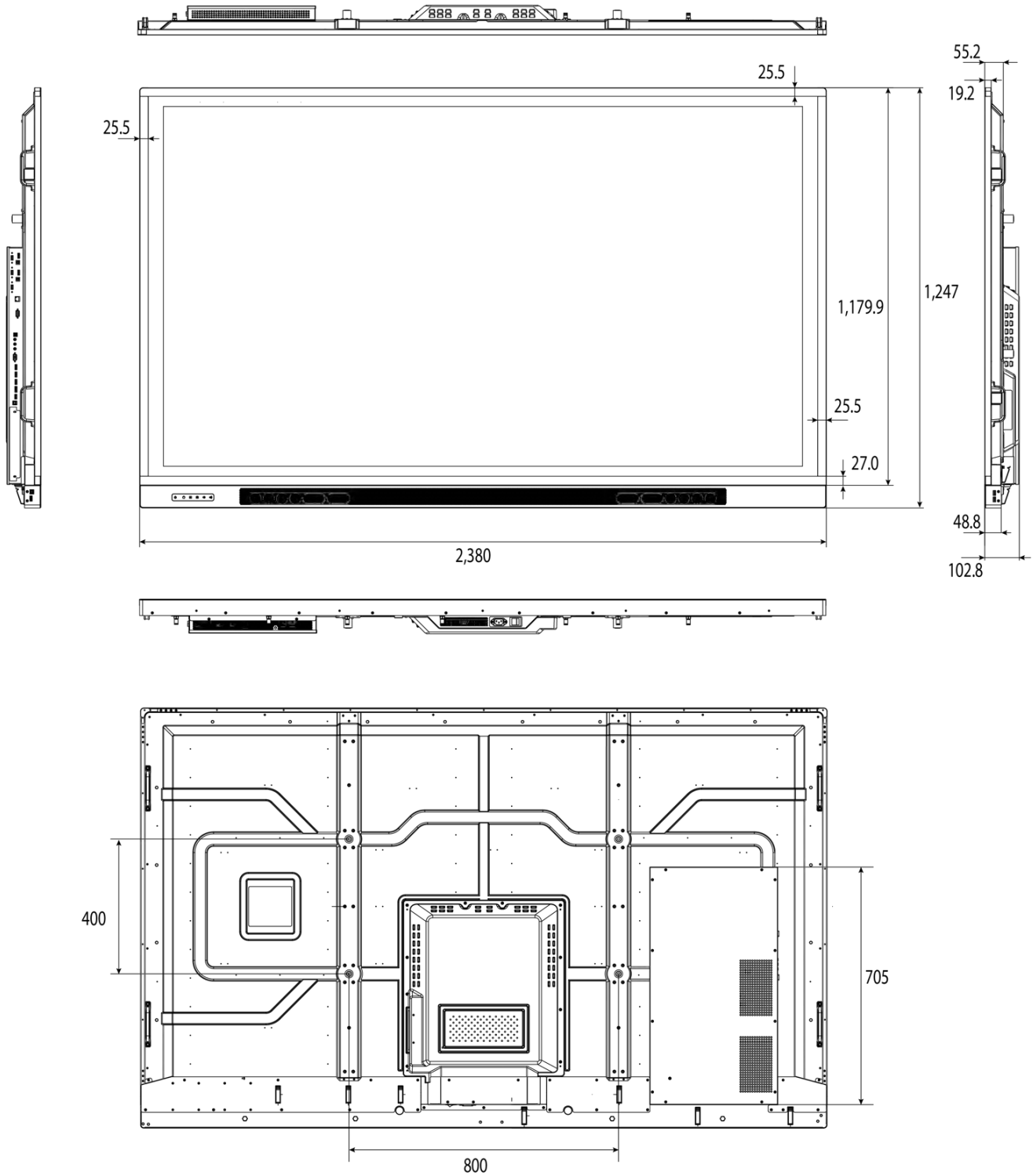

**Figure 7-2. AVF-8650 Display Dimensions (mm)**

# Notes

# Appendix I: Moving and Carrying Notice

## Moving the Display

Moving the display requires at least two people. Attempting to move the display with one person may result in dropping the display and/or serious injury. When moving a display in its shipping carton, lift the carton using the white handles.

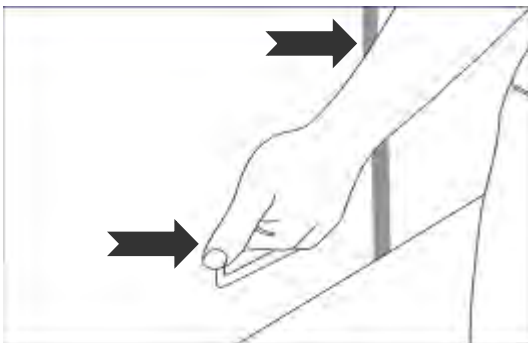
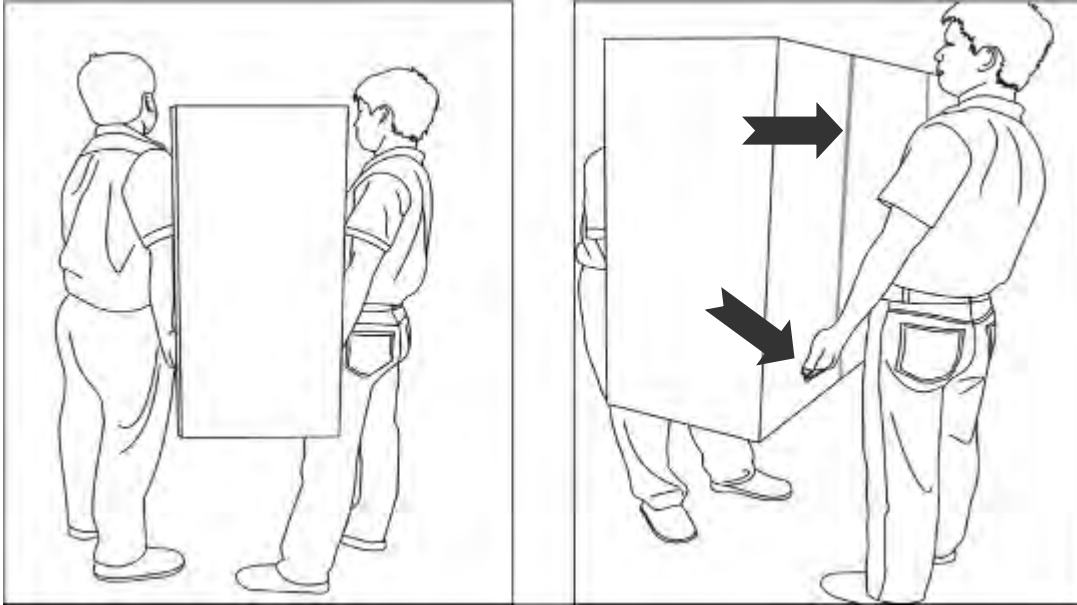

## Carrying the Display

This display is heavy; please follow proper lifting technique, as pictured below. Failure to do so may cause injury.





# Appendix II: Installing a Wall Mount

Follow the manual instructions for the type of mount you have selected. Refer all servicing to qualified service personnel.

Moving the display requires at least two people. Make sure you use the handles in the back of the display while lifting or moving the display, to avoid touching the front panel during the move.

Before installing, please make sure the wall is strong enough to hold the necessary weight of the display and the mount.

Step1. Keep the display facing the ground and place it on a flat object.

Step2. Remove the screws (M8\*15) from the back of the display.

Step3. Align the wall brackets with the mounting holes and attach the brackets to the display using the screws removed in Step 2.

Caution: Longer screws will damage the display.

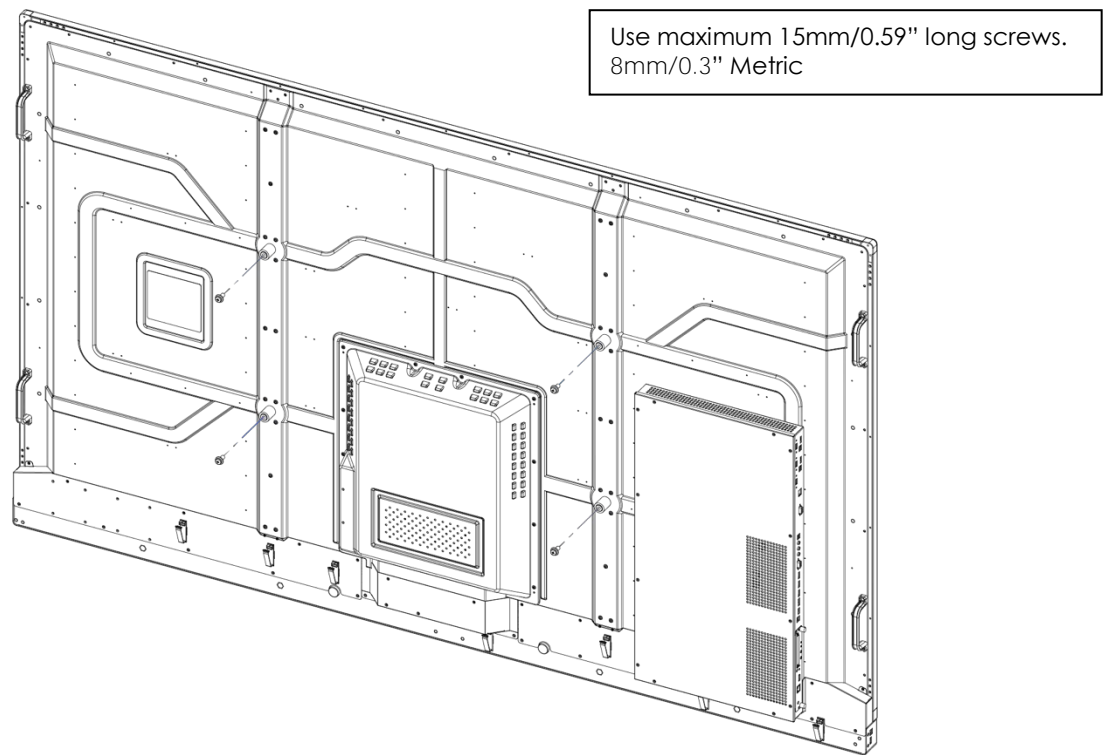

## NOTE

To safely mount the display on a wall:

- Use only the approved wall-mount kit designed for the display.
- Make sure the tilt degree of the wall does not exceed 2 degrees.

Rear Tilt



Forward Tilt



# Appendix III: Installing an OPS Module

Follow the steps below to install an OPS module.

- Step 1 Ensure that the display is turned off (power socket on rear of display).
- Step 2 Use a screw driver to unscrew the OPS slot cover on the display input panel. Do not lose the screws (M4\*6) that are removed.
- Step 3 Install the OPS module by sliding it gently into the OPS slot until you hear a click, indicating the module is securely inserted. When using an Avocor OPS PC, the fan should be facing to the backside of the display. Do not apply by force.
- Step 4 Secure the OPS module in position, by screwing it onto the display input panel using the screws (M4\*6) that were removed earlier.
- Step 5 Turn on the interactive display. When using an Avocor OPS PC a green light on the side of the OPS PC should appear, indicating that the OPS PC is switched on and operational.

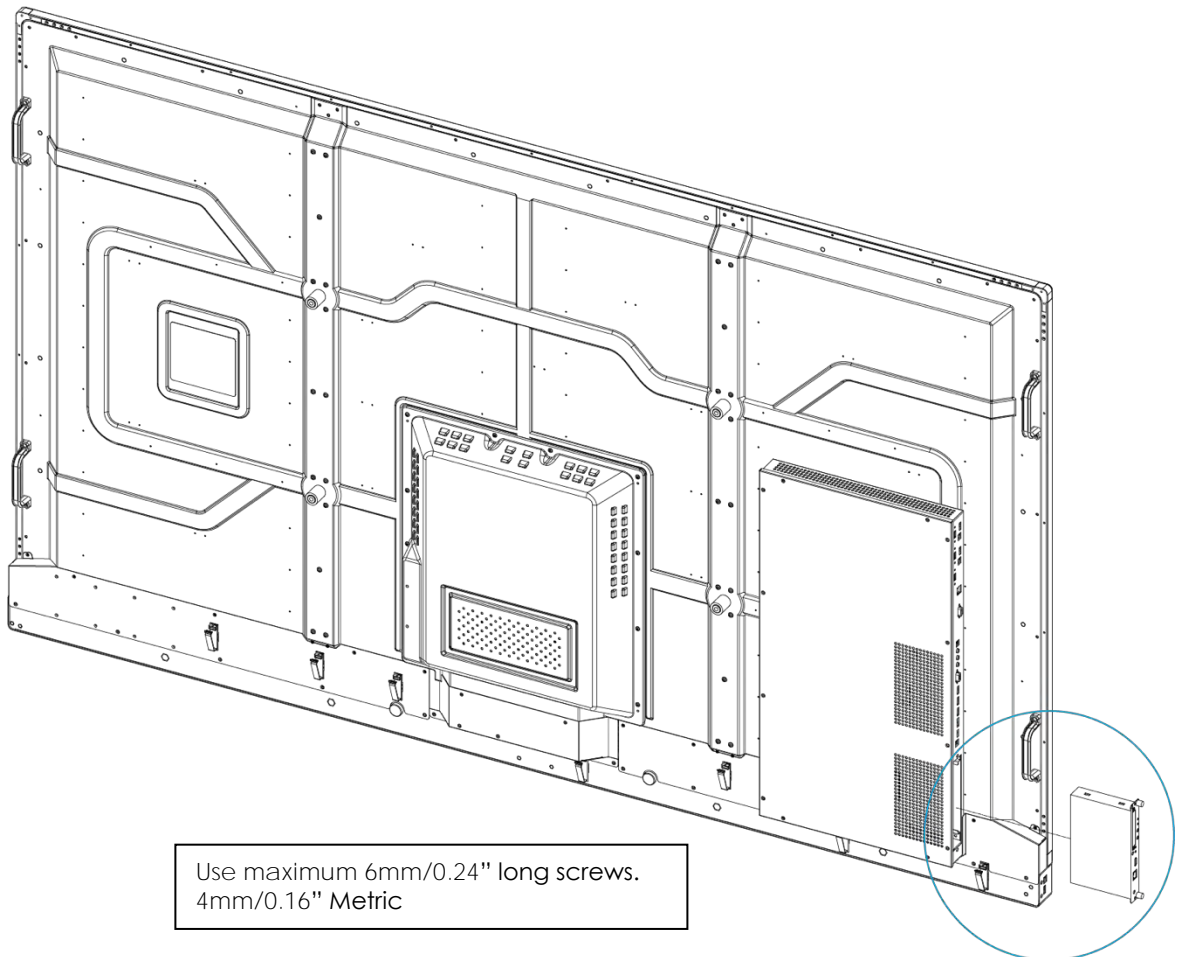

## NOTE

- When installing or uninstalling an OPS PC, the display must be switched off. If the display is on when performing the installation or uninstallation of the OPS PC, this could cause damage to either the display or OPS PC invalidating the warranty for both.
- The right bottom handle can be unscrewed for OPS module installation. Please reinstall the handle after inserting the OPS module.

# Appendix IV: Wall Mount Safety Notes

- 1.** Please make sure if the bracket is fixed to the solid wall / solid pillar for fear of falling due to heavy weight.

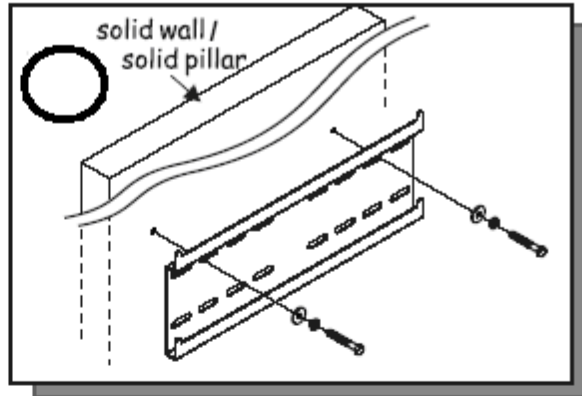
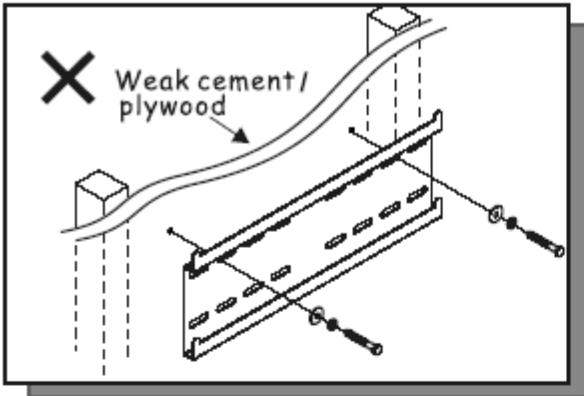

- 2.** After assembling, please don't pull or shake violently.

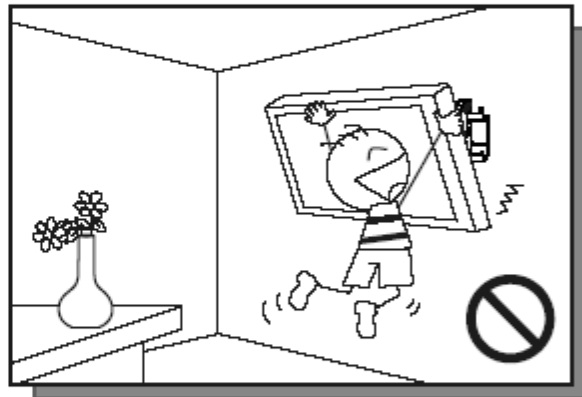
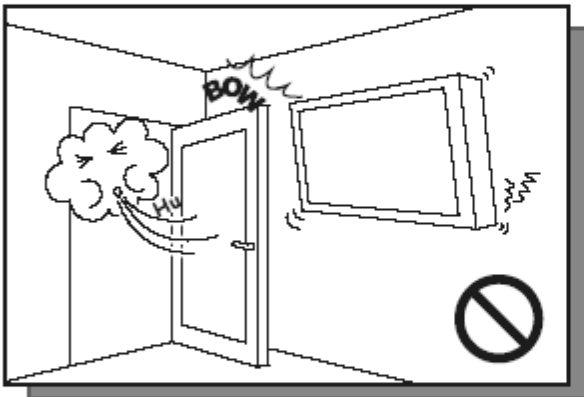

- 3.** Please don't install the bracket directly under the sunshine or humidity / high temperature places for fear that the quality is effected.

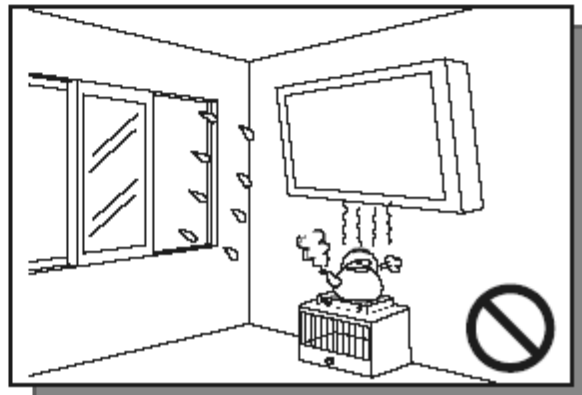
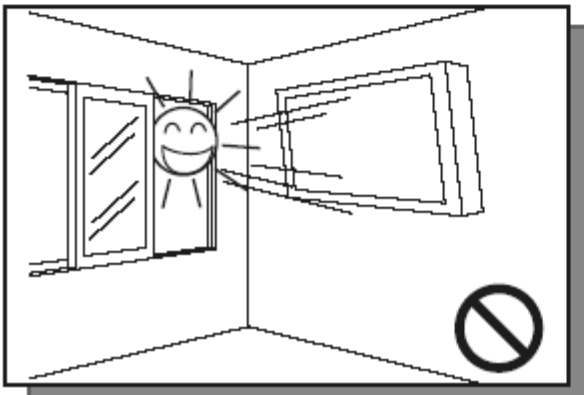

**4.**

Installing the bracket over 10 cm from each wall side and being vertical to the ground is the suggested installing position.

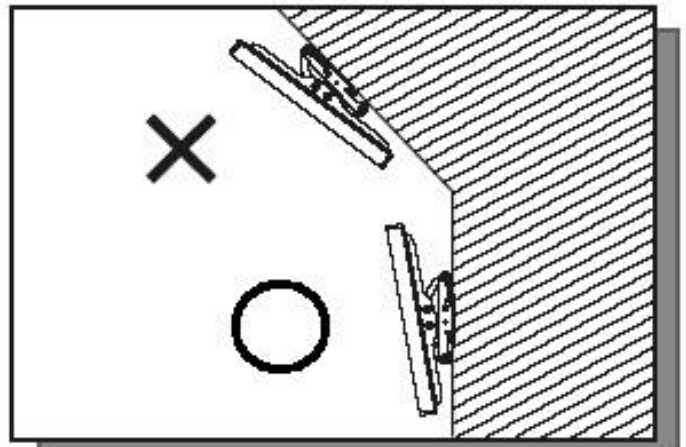
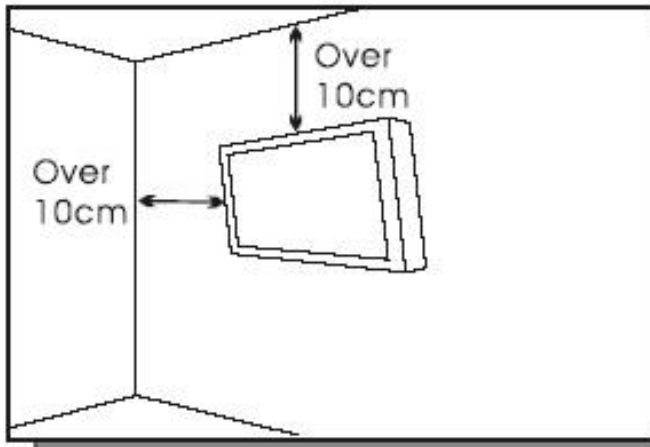

**5.**

Please make sure to hang on the mounting hooks firmly.

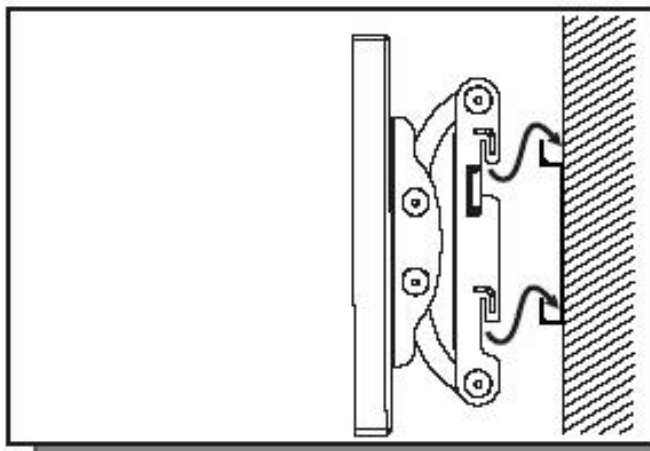

**6.**

The flat screen must be put in the mid of the bracket for fear of slope.

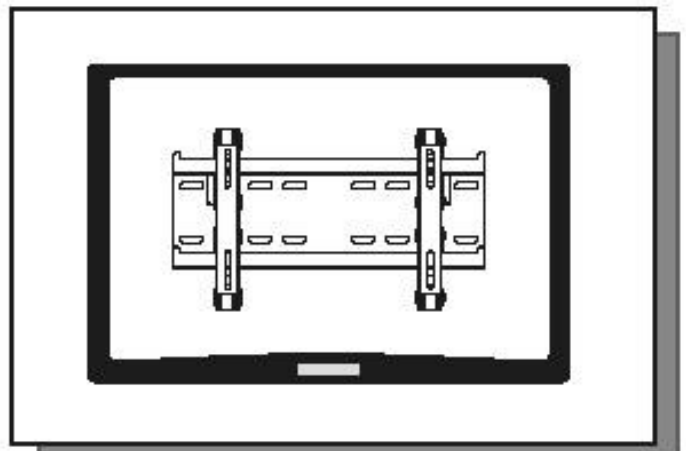

# Appendix V: Ethernet Remote Control Settings

The device can be controlled by opening a browser and connecting to web server directly.

1. Open a browser and type the IP address :192.168.2.1 into the address bar and enter.
2. The browser will prompt the small window which will ask for your username and password.

USER LOG IN

Site: 192.168.2.1

ID:

Password:

OK

3. Enter the username and password to login by using the following information then click the OK button.

Default IP	192.168.2.1
Default ID	admin
Default Password	system

## Configurations

### Administrator

#### Authentication Configuration

##### Administrator

[Authentication Configuration](#)

[System IP Configuration](#)

[Network Status](#)

[Display Status](#)

[Load default setting](#)

[Firmware update](#)

[Boot Loader upgrade](#)

##### TCP Mode

##### UDP Mode

##### UART

##### SMTP

##### Reset Device

##### Logout

#### Authentication Configuration

Setting	Value
Username	<input type="text" value="admin"/> max:15
Password Confirm	<input type="password" value="•••••"/> max:15 <input type="password" value="•••••"/>

Please refresh web page after press "updated" button.

Note:

Comment name only can use "0-9", "a-z", "A-Z"

## System IP Configuration

### Administrator

[Authentication Configuration](#)

[System IP Configuration](#)

[Network Status](#)

[Display Status](#)

[Load default setting](#)

[Firmware update](#)

[Boot Loader upgrade](#)

[TCP Mode](#)

[UDP Mode](#)

[UART](#)

[SMTP](#)

[Reset Device](#)

[Logout](#)

## System IP Configuration

Setting	Value
IP Address	<input type="text" value="192"/> . <input type="text" value="168"/> . <input type="text" value="2"/> . <input type="text" value="1"/>
Subnet Mask	<input type="text" value="255"/> . <input type="text" value="255"/> . <input type="text" value="255"/> . <input type="text" value="0"/>
Gateway	<input type="text" value="192"/> . <input type="text" value="168"/> . <input type="text" value="2"/> . <input type="text" value="1"/>
DNS	<input type="text" value="192"/> . <input type="text" value="168"/> . <input type="text" value="2"/> . <input type="text" value="1"/>
IP Configure	<input type="radio"/> Static <input checked="" type="radio"/> DHCP
VLAN Tag	<input checked="" type="radio"/> Disable <input type="radio"/> Enable : VLAN ID <input type="text" value="0"/>

Please refresh web page after press "updated" button.

## Network Status

### Administrator

[Authentication Configuration](#)

[System IP Configuration](#)

[Network Status](#)

[Display Status](#)

[Load default setting](#)

[Firmware update](#)

[Boot Loader upgrade](#)

[TCP Mode](#)

[UDP Mode](#)

[UART](#)

[SMTP](#)

[Reset Device](#)

[Logout](#)

## Network Status

Kernel Version	V3021 (Feb 17 2014 14:42:18)
MAC Address	00:1F:B6:00:01:DB
Nickname	<input type="text" value="NetUART"/> <input type="button" value="Update"/> Please refresh web page after press "updated" button.

Note:

Comment name only can use "0-9","a-z","A-Z","\_","-"

## Load Default Setting

### Administrator

[Authentication Configuration](#)

[System IP Configuration](#)

[Network Status](#)

[Display Status](#)

[Load default setting](#)

[Firmware update](#)

[Boot Loader upgrade](#)

[TCP Mode](#)

[UDP Mode](#)

[UART](#)

[SMTP](#)

[Reset Device](#)

[Logout](#)

Load Default Setting to EEPROM

## Firmware Update

### Administrator

- [Authentication Configuration](#)
- [System IP Configuration](#)
- [Network Status](#)
- [Display Status](#)
- [Load default setting](#)
- [Firmware update](#)
- [Boot Loader upgrade](#)

### TCP Mode

### UDP Mode

### UART

### SMTP

### Reset Device

### Logout

## Firmware update

Load

## Boot Loader Upgrade

### Administrator

- [Authentication Configuration](#)
- [System IP Configuration](#)
- [Network Status](#)
- [Display Status](#)
- [Load default setting](#)
- [Firmware update](#)
- [Boot Loader upgrade](#)

### TCP Mode

### UDP Mode

### UART

### SMTP

### Reset Device

### Logout

## Upgrade the Boot Loader

Load

## TCP Mode

### Administrator

[Authentication Configuration](#)

[System IP Configuration](#)

[Network Status](#)

[Display Status](#)

[Load default setting](#)

[Firmware update](#)

[Boot Loader upgrade](#)

### TCP Mode

### UDP Mode

### UART

### SMTP

### Reset Device

### Logout

## TCP Control

Item	Value
Telnet Server/Client	<input checked="" type="radio"/> Server <input type="radio"/> Client <input type="radio"/> Disable
Data Port Number	<input type="text" value="23"/>
Remote Server IP Address	<input checked="" type="radio"/> IP <input type="text" value="210"/> . <input type="text" value="200"/> . <input type="text" value="181"/> . <input type="text" value="102"/> <input type="radio"/> Domain Name <input type="text" value="0"/>
Client mode inactive timeout	<input type="text" value="20"/> minute (1~99,0=Disable)
Server mode protect timeout	<input type="text" value="60"/> minute (1~98,0=Disable,99=Can't replace)
<input type="button" value="Update"/> Please refresh web page after press "updated" button.	

### Telnet Server/Client

Set the device to be a Telnet Server or Client.

### Port Number

When in Server mode, assign the port number used to connect remotely. When in Client mode, assign the port number for the device to connect to the remote site.

### Remote Server IP Address

When in Client mode, the device will connect to the remote server with the IP address set here.

### Client mode inactive timeout

When NET2UAR is operating in TCP client mode, it will always try to connect with the remote server. The time configured here is for NET2UART to rebuild connection after timeout.

### Server mode protect timeout

When NET2UART is operating in TCP server mode, it would protect the TCP connection from getting replaced in the period of the time set here.



# UDP Mode

**Administrator**

- [Authentication Configuration](#)
- [System IP Configuration](#)
- [Network Status](#)
- [Display Status](#)
- [Load default setting](#)
- [Firmware update](#)
- [Boot Loader upgrade](#)

- TCP Mode**
- UDP Mode**
- UART**
- SMTP**
- Reset Device**
- Logout**

## UDP

Item	Value	
Mode	<input type="radio"/> Listen <input type="radio"/> Normal <input checked="" type="radio"/> Disable	
Local Port	21	
Remote Address	IP	Port
	<input checked="" type="radio"/> 0 . 0 . 0 . 0 IP <input type="radio"/> Domain Name	0
	<input checked="" type="radio"/> 0 . 0 . 0 . 0 IP <input type="radio"/> Domain Name	0
	<input checked="" type="radio"/> 0 . 0 . 0 . 0 IP <input type="radio"/> Domain Name	0
	<input checked="" type="radio"/> 0 . 0 . 0 . 0 IP <input type="radio"/> Domain Name	0
	<input checked="" type="radio"/> 0 . 0 . 0 . 0 IP <input type="radio"/> Domain Name	0
	<input checked="" type="radio"/> 0 . 0 . 0 . 0 IP <input type="radio"/> Domain Name	0
	<input checked="" type="radio"/> 0 . 0 . 0 . 0 IP <input type="radio"/> Domain Name	0
	<input checked="" type="radio"/> 0 . 0 . 0 . 0 IP <input type="radio"/> Domain Name	0
	<input checked="" type="radio"/> 0 . 0 . 0 . 0 IP <input type="radio"/> Domain Name	0
<input type="button" value="Update"/>		
Please refresh web page after press "updated" button.		

### Status

When TCP mode is set as Server mode or Client mode, the UDP mode would be disabled automatically, and vice versa.

### Local Port

Assign the port number here to allow the device to open for the remote site to send data via UDP. The IP address of the remote site must be set in the Remote Address table, or NET2UART will ignore its data.

### Remote Address

The Remote Address table allows 10 entries of remote site IP addresses and ports. When NET2UART is sending data to network, the data will be sent to the each remote IP address entered in the table simultaneously. The port number is the remote site port number that NET2UART will send data to via UDP.

If the port number is set as "0", the NET2UART will use the port number that the remote site sends data from as the destination port number, or use the local port number as the destination port number if the remote site has not sent data to NET2UART.

# UART

## Administrator

- [Authentication Configuration](#)
- [System IP Configuration](#)
- [Network Status](#)
- [Display Status](#)
- [Load default setting](#)
- [Firmware update](#)
- [Boot Loader upgrade](#)

## TCP Mode

## UDP Mode

## UART

## SMTP

## Reset Device

## Logout

## UART Control

Item	Setting
Mode	RS232
Baudrate	115200
Character Bits	8
Parity Type	none
Stop Bit	1
Hardware Flow Control	none
Uart Memory Overflow count	0M,0K,0Byte
Uart FIFO Overflow count	0times
Delimiter	<input type="checkbox"/> Character 1: 00, <input type="checkbox"/> Character 2: FF <input type="checkbox"/> Silate time: 5 (1~255)*200ms <input type="checkbox"/> Drop Character
<input type="button" value="Update"/>	
Please refresh web page after press "updated" button.	

Mode

Select the UART interface.

Baud rate

Select the baud rate of UART interface.

Character Bits

Select the number of character bits of UART interface.

Parity Type

Select the parity type of UART interface.

Stop Bit

Select the stop bit type of UART interface.

Hardware Flow Control

Select the flow control type of UART interface. The hardware flow control will use CTS/RTS for the control signals.

Uart Memory Overflow count

Shows the number of overflow bytes in network buffer.

Uart FIFO Overflow count

Shows the number of overflow times in UART RX buffer.

## Delimiter

- Character 1 & 2:

Set Character 1 and/or Character 2 to be the delimiter.

Once the delimiter is active, NET2UART would monitor all data received from UART. All data received from UART will be stored in NET2UART internal buffer first, and will only be sent to Ethernet once the delimiter is detected. If the delimiters have not been detected and the internal buffer of NET2UART is stuffed, the incoming data will overwrite the previous data stored in NET2UART.

- Drop Character:

The Drop Character is set to drop delimiter or not. If Drop Character is active, the delimiter received from UART will not be sent out to Ethernet.

- Silent time:

Once the Silent time is active, NET2UART will keep all data received from UART in its internal buffer and check the time period of no data received from UART. It will then send out the internal data once the time is out.

## SMTP

### Administrator

[Authentication Configuration](#)

[System IP Configuration](#)

[Network Status](#)

[Display Status](#)

[Load default setting](#)

[Firmware update](#)

[Boot Loader upgrade](#)

[TCP Mode](#)

[UDP Mode](#)

[UART](#)

[SMTP](#)

[Reset Device](#)

[Logout](#)

### SMTP setup

Enable SMTP	<input type="checkbox"/> Enable,Port: 25
SMTP server address	smtp.xxx.yyy
SMTP Login Information	<input type="checkbox"/> Enable Username: username, Password: ●●●●●●
Mail to	xxx@yyy.zzz max: 200
Mail from	xxx@yyy.zzz

SMTP 01 Warning	
Subject	Power Status Change Alert
Message Body	SMTP 01 body max: 100

SMTP 02 Warning	
Subject	Source Change Alert
Message Body	SMTP 02 body max: 100

SMTP 03 Warning	
Subject	Signal Lost Alert
Message Body	SMTP 03 body max: 100

## Reset Device

Reset NET2UART module.

**Administrator**

[TCP Mode](#)

[UDP Mode](#)

[UART](#)

[SMTP](#)

[Reset Device](#)

[Logout](#)

Reset Device

Reset